

AXUS HIGH TEMPERATURE AXIAL FANS

WIDE RANGE OF SMOKE EXTRACT FANS FOR
HIGH TEMPERATURE APPLICATIONS.



BENEFITS

TRIED & TESTED

Nuaire's high temperature fans have been tested in accordance with the latest legislation and testing procedures. High temperature fans have been tested to EN12101-3 (2002) 300°C for 2 hours or 400°C for 2 hours.

HIGH TEMPERATURE PERFORMANCE

Units are suitable for smoke reservoir and non smoke reservoir applications. Units are dual purpose for day to day plus 'one off' emergency use.

WIDE RANGE

The widest range of high temperature axials available. A fan to match every application ensures maximum efficiency and saving costly energy.

HEAVY GAUGE GALVANISED STEEL CONSTRUCTION

Ensuring strength, durability, protection from damage during installation and corrosion resistant for a long life.

TESTED TO THE HIGHEST STANDARDS

Air performance to BS848 (part 1) 2007 and ISO5801 (part1) 2007 with acoustic performance to AMCA300. All carried out at our own test facilities to ensure the most accurate performance figures and noise data is provided, constantly monitored to give you up to date information you can rely on.

FAN OPTIONS

As well as contra-rotating & run/standby series, other options are available including 400°C for 2 hours & two speed.

COMPREHENSIVE ANCILLARIES

Including a range of attenuators, and mounting ancillaries all pre-selected for the individual fan to ensure a perfect match and eliminate any on-site fitting problems.

WARRANTY

High Temperature Axial fans have a 3 year warranty.

MATCHING ANCILLARIES

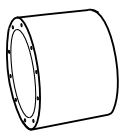

Attenuators - Standard and Long options available.

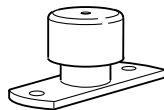

Anti Vibration Mounts

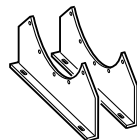

Mounting Brackets.



Flexible Connectors.



Matching Flanges.



Inlet Cones.

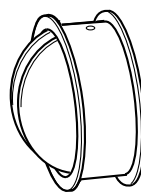

Anti-backdraft Damper.

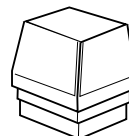

Arc Cowl.

See page 360 for further details on ancillaries.

CASE OPTIONS

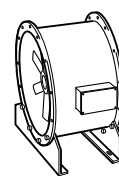

AXUS Circular Axial.

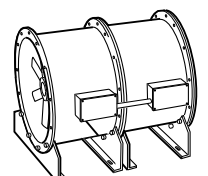

AXUS Contra-Rotating.

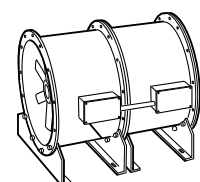

AXUS Run & Standby.

DUTY RANGE - AXUS HIGH TEMPERATURE LONG CASED AXIAL FANS

Below is an indication of the overall duty range, a selection of which is covered in this brochure. Please contact Nuair Technical on (029) 2085 8200 for any duty outside the range indicated.

AXUS - Axial flow fans for smoke control (300°C for 2 Hours)

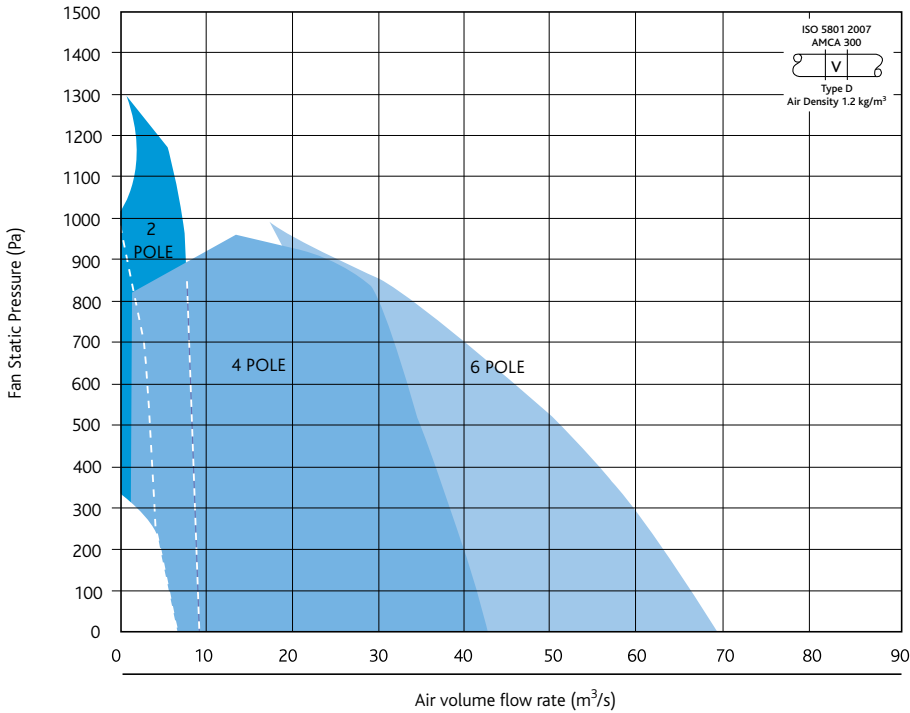

AXUS - Axial flow fans for smoke control (400°C for 2 Hours)

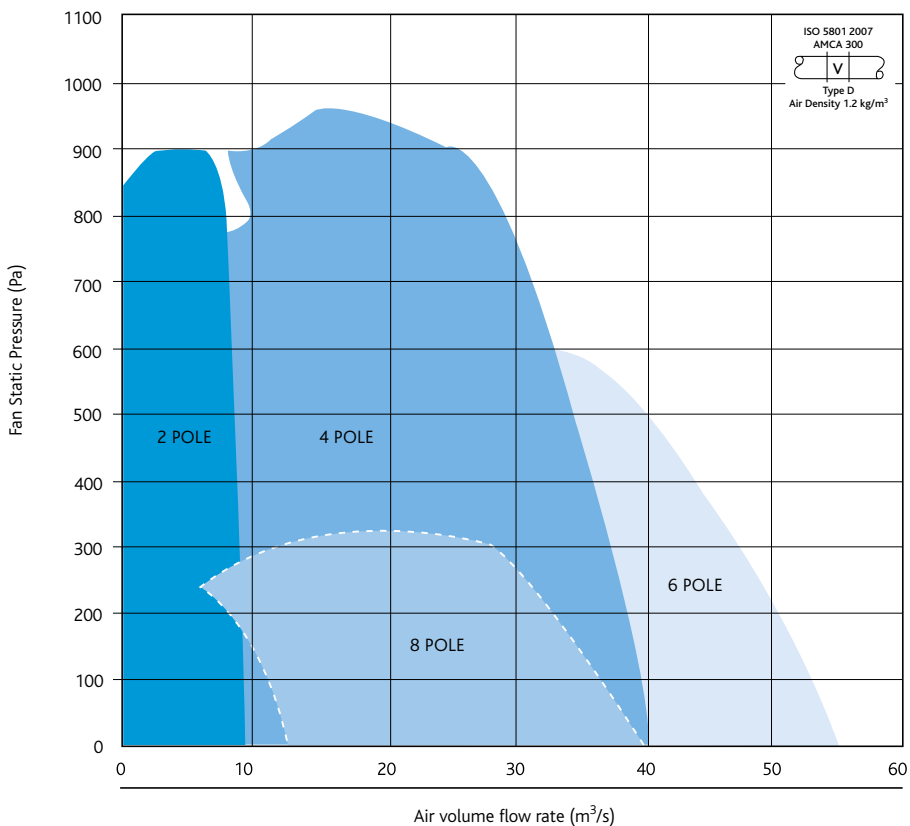

Casing

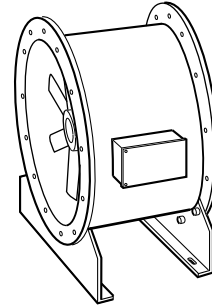

Code descriptions

AX 100 A - 4 1 3 A 7 T

1	2	3	4	5	6	7	8	9

1. Axus long cased Axial
2. Case diameter in cm
3. Impeller specification reference
4. Motor speed in poles
5. Impeller blade angle reference
6. Electrical supply in phase
3 = 400V, 50Hz three phase
7. Impeller material
A = Aluminium
S = Steel
8. Operating Temperature
7 = 300°C for 2 hours
8 = 400°C for 2 hours
9. Other options (combinations possible)
T = Two speed (full and half)
T6 = Two speed (full and two thirds (4/6 pole only))

PERFORMANCE - AXUS LONG CASED AXIAL UNITS - 315MM Ø (300°C FOR 2 HOURS)

315mm Ø 4 Pole/1440 RPM

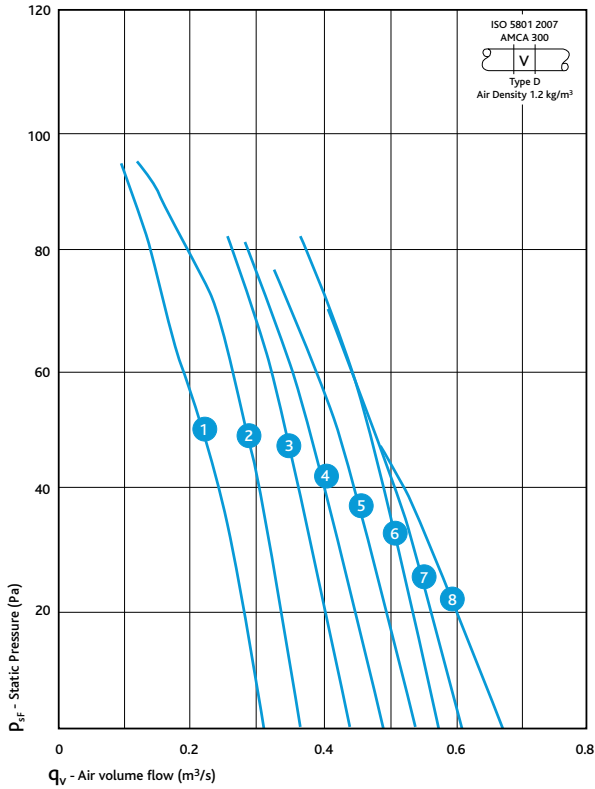

315mm Ø 2 Pole/2800 RPM

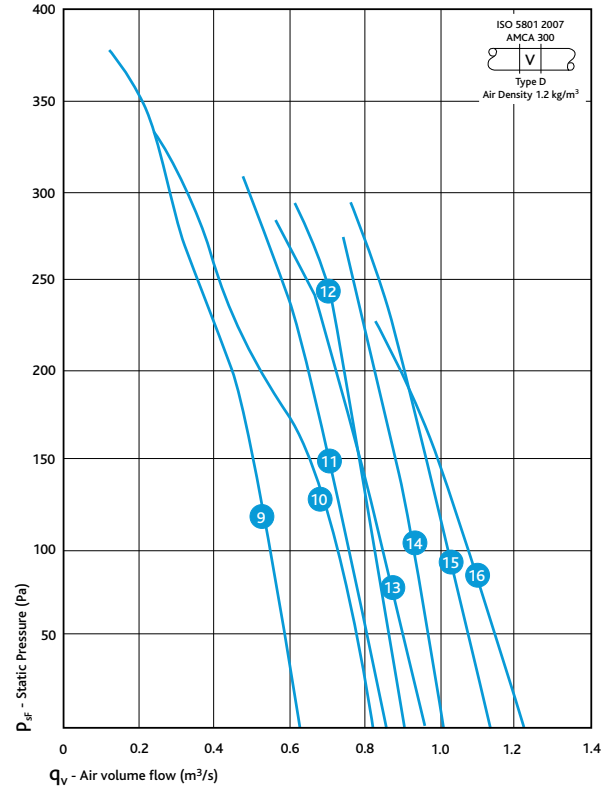

NOTE: THE CURVES ABOVE ARE INDICATIVE OF THE RANGE, A MORE COMPREHENSIVE SELECTION IS AVAILABLE, PLEASE CONTACT NUAIRE TECHNICAL, OR OBTAIN A COPY OF OUR FAN SELECTOR PROGRAMME VIA OUR WEBSITE.

ELECTRICAL & SOUND

Curve No	Unit Code	Blade Angle°	Speed RPM	Unit kg	A.V. Set	Motor frame size	3 Phase (400V)			In-duct inlet sound power levels dB re 1pW Octave band mid frequency Hz						Breakout dBA @ 3m	
							Motor kW	FLC amps	SC amps	125	250	500	1K	2K	4K		8K
315 Ø - 4 Pole/1440rpm																	
1	AX31M-413A7	20°	1415	21	NAV38	80	0.55	1.5	7.2	85	72	65	61	58	50	42	42
2	AX31X-413A7	25°	1415	21	NAV38	80	0.55	1.5	7.2	77	72	63	61	58	48	42	40
3	AX31X-423A7	30°	1415	21	NAV38	80	0.55	1.5	7.2	79	72	64	61	58	49	43	40
4	AX31X-443A7	35°	1415	21	NAV38	80	0.55	1.5	7.2	77	70	63	62	58	48	41	39
5	AX31X-463A7	40°	1415	21	NAV38	80	0.55	1.5	7.2	82	71	64	63	59	50	44	41
6	AX31F-443A7	40°	1415	21	NAV38	80	0.55	1.5	7.2	70	75	63	65	61	53	46	41
7	AX31F-453A7	45°	1415	21	NAV38	80	0.55	1.5	7.2	71	72	64	65	61	55	48	40
8	AX31B-453A7	45°	1415	21	NAV38	80	0.55	1.5	7.2	71	71	63	61	59	55	50	39
315 Ø - 2 Pole/2800rpm																	
9	AX31M-213A7	20°	2875	23	NAV38	80	0.75	1.65	11.2	81	97	80	78	74	70	63	57
10	AX31B-213A7	25°	2875	23	NAV38	80	0.75	1.65	11.2	72	78	75	75	72	69	63	5
11	AX31X-223A7	30°	2875	23	NAV38	80	0.75	1.65	11.2	85	86	80	77	73	68	64	54
12	AX31F-223A7	30°	2875	23	NAV38	80	0.75	1.65	11.2	79	78	80	76	73	70	65	52
13	AX31X-243A7	35°	2875	23	NAV38	80	0.75	1.65	11.2	82	89	79	79	75	71	64	54
14	AX31F-233A7	35°	2875	23	NAV38	80	0.75	1.65	11.2	79	77	78	77	74	71	65	52
15	AX31F-243A7	40°	2875	23	NAV38	80	0.75	1.65	11.2	82	79	79	79	74	69	65	53
16	AX31B-243A7	40°	2875	23	NAV38	80	0.75	1.65	11.2	76	80	78	78	73	68	64	50

Notes relating to the table: The electrical and sound information in the table is **nominal**. Breakout dBA@3m is spherical, free field. Start currents (sc.) are for DOL starting.

See page 360 for further details on ancillaries.

SMOKE FANS

AXUS HIGH TEMPERATURE AXIAL FANS

TECHNICAL INFORMATION

PERFORMANCE - AXUS LONG CASED AXIAL UNITS - 350MM Ø (300°C FOR 2 HOURS)

350mm Ø 4 Pole/1440 RPM

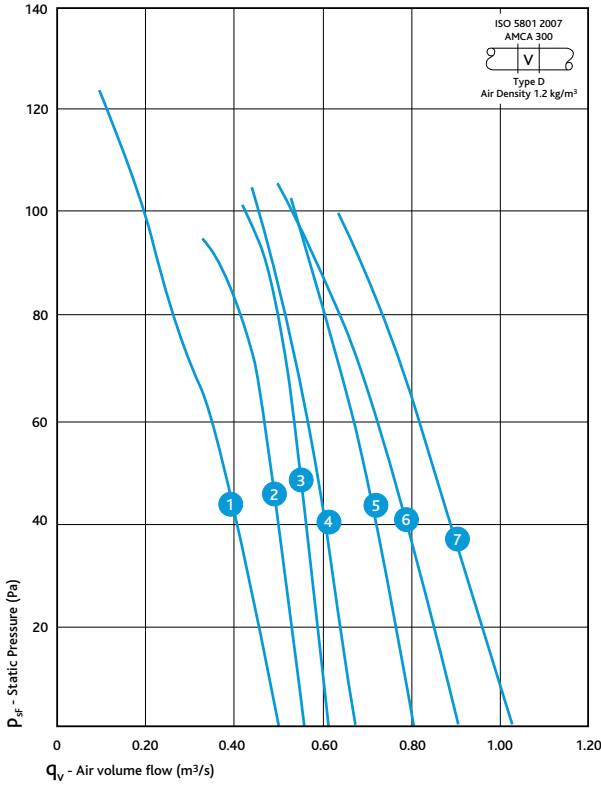

350mm Ø 2 Pole/2800 RPM

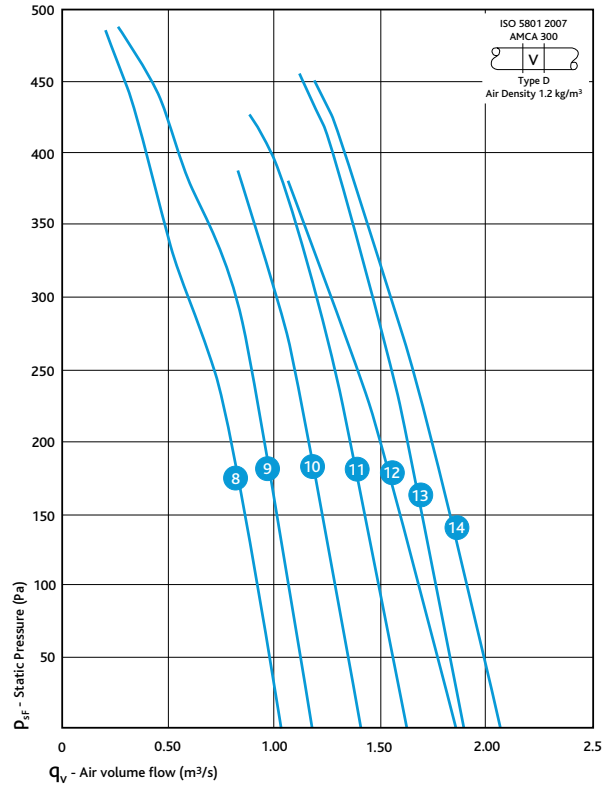

NOTE: THE CURVES ABOVE ARE INDICATIVE OF THE RANGE, A MORE COMPREHENSIVE SELECTION IS AVAILABLE, PLEASE CONTACT NUAIRE TECHNICAL, OR OBTAIN A COPY OF OUR FAN SELECTOR PROGRAMME VIA OUR WEBSITE.

ELECTRICAL & SOUND

Curve No	Unit Code	Blade Angle°	Speed RPM	Unit kg	A.V. Set	Motor frame size	3 Phase (400V)			In-duct inlet sound power levels dB re 1pW						Breakout dBA @ 3m	
							Motor kW	FLC amps	SC amps	Octave band mid frequency Hz							
										125	250	500	1K	2K	4K	8K	
350 Ø - 4 Pole/1440 rpm																	
1	AX35M-413A7	20°	1415	22	NAV38	80	0.55	1.5	7.2	81	69	66	64	61	56	50	44
2	AX35F-413A7	25°	1415	22	NAV38	80	0.55	1.5	7.2	75	72	66	65	63	57	49	41
3	AX35D-413A7	25°	1415	22	NAV38	80	0.55	1.5	7.2	69	67	66	62	62	55	48	42
4	AX35X-423A7	30°	1415	22	NAV38	80	0.55	1.5	7.2	89	77	66	63	59	50	43	48
5	AX35F-433A7	35°	1415	22	NAV38	80	0.55	1.5	7.2	69	78	64	64	62	56	49	44
6	AX35F-443A7	40°	1415	22	NAV38	80	0.55	1.5	7.2	73	75	64	63	59	55	50	42
7	AX35F-453A7	45°	1415	22	NAV38	80	0.55	1.5	7.2	74	78	65	65	61	57	53	45
350 Ø - 2 Pole/2800rpm																	
8	AX35M-213A7	20°	2875	23	NAV38	80	1.1	2.3	17.9	81	88	79	81	76	72	67	55
9	AX35X-213A7	25°	2875	26	NAV38	80	1.1	2.3	17.9	84	89	81	80	76	74	66	57
10	AX35X-223A7	30°	2875	26	NAV38	80	1.1	2.3	17.9	85	96	81	81	77	74	66	60
11	AX35X-243A7	35°	2875	26	NAV38	80	1.1	2.3	17.9	87	88	83	84	79	75	68	58
12	AX35M-273A7	40°	2875	23	NAV38	80	1.1	2.3	17.9	86	101	82	82	79	74	69	65
13	AX35F-243A7	40°	2875	22	NAV38	90	1.5	3.1	25.7	90	85	86	84	81	76	71	60
14	AX35F-253A7	45°	2875	22	NAV38	90	1.5	3.1	25.7	90	85	86	84	81	76	71	60

Notes relating to the table: The electrical and sound information in the table is **nominal**. Breakout dBA@3m is spherical, free field. Start currents (sc.) are for DOL starting.

See page 360 for further details on ancillaries.

PERFORMANCE - AXUS LONG CASED AXIAL UNITS - 400MM Ø (300°C FOR 2 HOURS)

400mm Ø 4 Pole/1440 RPM

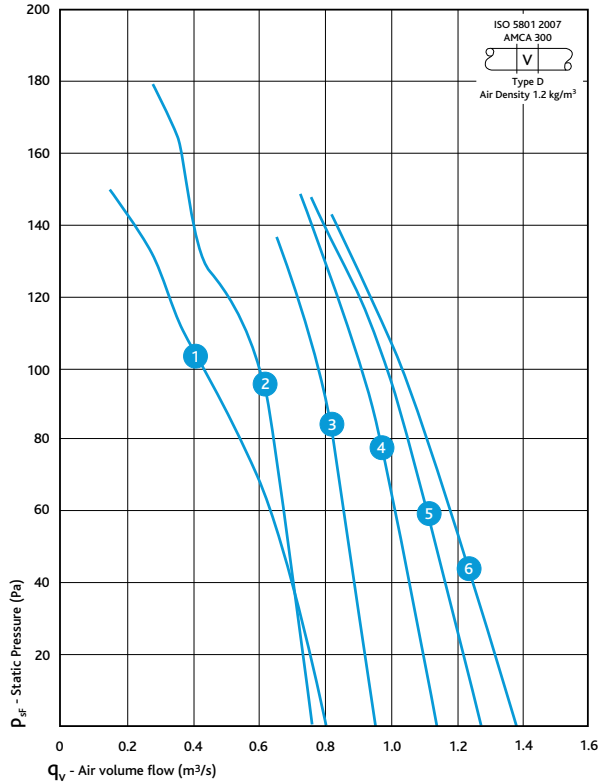

400mm Ø 2 Pole/2800 RPM

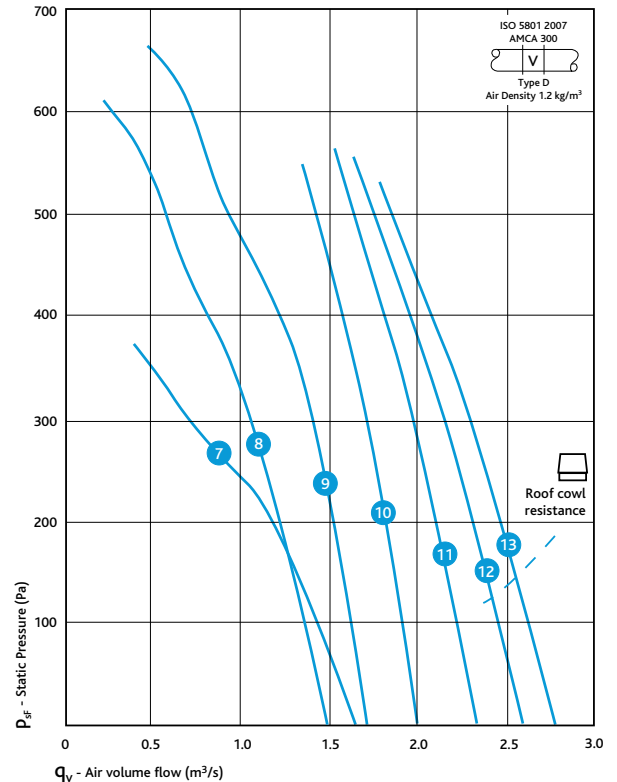

NOTE: THE CURVES ABOVE ARE INDICATIVE OF THE RANGE, A MORE COMPREHENSIVE SELECTION IS AVAILABLE, PLEASE CONTACT NUAIRE TECHNICAL, OR OBTAIN A COPY OF OUR FAN SELECTOR PROGRAMME VIA OUR WEBSITE.

ELECTRICAL & SOUND

Curve No	Unit Code	Blade Angle ^o	Speed RPM	Unit kg	A.V. Set	Motor frame size	3 Phase (400V)			In-duct inlet sound power levels dB re 1pW Octave band mid frequency Hz						Breakout dBA @ 3m	
							Motor kW	FLC amps	SC amps	125	250	500	1K	2K	4K		8K
400 Ø - 4 Pole/1440 rpm																	
1	AX40D-413A7	25 ^o	1415	26	NAV38	80	0.55	1.5	7.2	71	81	69	66	65	59	51	49
2	AX40I-413A7	25 ^o	1415	30	NAV38	80	0.55	1.5	7.2	72	77	73	69	67	63	54	45
3	AX40I-423A7	30 ^o	1415	30	NAV38	80	0.55	1.5	7.2	69	76	70	66	64	60	53	44
4	AX40I-433A7	35 ^o	1415	30	NAV38	80	0.55	1.5	7.2	72	79	70	67	63	58	53	45
5	AX40I-443A7	40 ^o	1415	30	NAV38	80	0.55	1.5	7.2	76	77	70	68	64	60	55	45
6	AX40I-453A7	45 ^o	1415	30	NAV38	80	0.55	1.5	7.2	76	77	71	69	64	60	55	46
400 Ø - 2 Pole/2800rpm																	
7	AX40C-213A7	25 ^o	2875	31	NAV38	80	0.75	1.65	11.2	81	90	83	80	75	71	69	59
8	AX40M-213A7	20 ^o	2875	31	NAV38	80	0.75	1.65	11.2	81	89	83	84	79	75	72	57
9	AX40F-213A7	25 ^o	2875	38	NAV39	90	1.5	3.1	25.7	78	82	86	83	81	78	74	58
10	AX40I-223A7	30 ^o	2875	39	NAV39	90	1.8	3.6	31.3	82	81	89	84	80	78	75	61
11	AX40I-233A7	35 ^o	2875	39	NAV39	90	2.2	4.4	39.6	85	83	90	84	80	75	70	62
12	AX40I-243A7	40 ^o	2875	41	NAV39	100	3	5.8	53	88	86	92	85	81	76	72	63
13	AX40I-253A7	45 ^o	2875	44	NAV39	100	3	5.8	53	92	87	90	90	85	80	76	63

Notes relating to the table: The electrical and sound information in the table is **nominal**. Breakout dBA@3m is spherical, free field. Start currents (sc.) are for DOL starting.

See page 360 for further details on ancillaries.

SMOKE FANS

AXUS HIGH TEMPERATURE AXIAL FANS

TECHNICAL INFORMATION

PERFORMANCE - AXUS LONG CASED AXIAL UNITS - 450MM Ø (300°C FOR 2 HOURS)

450mm Ø 4 Pole/1440 RPM

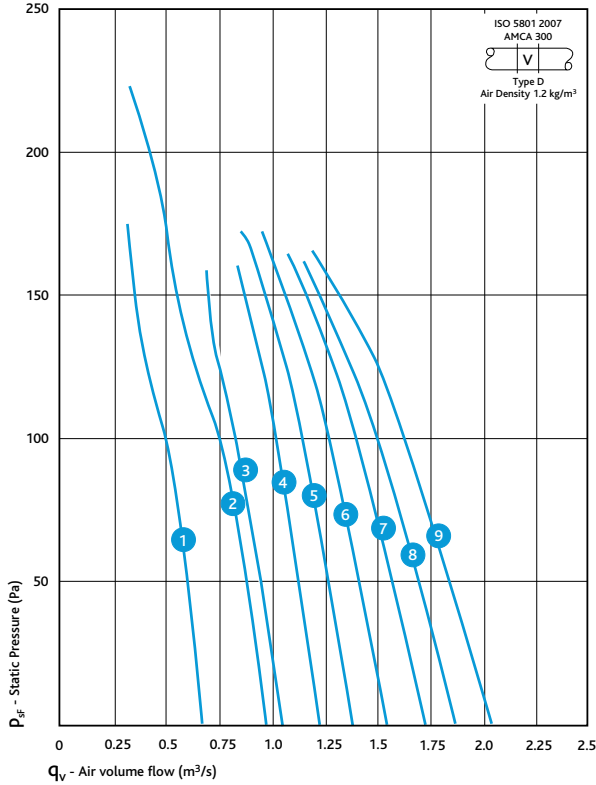

450mm Ø 2 Pole/2800 RPM

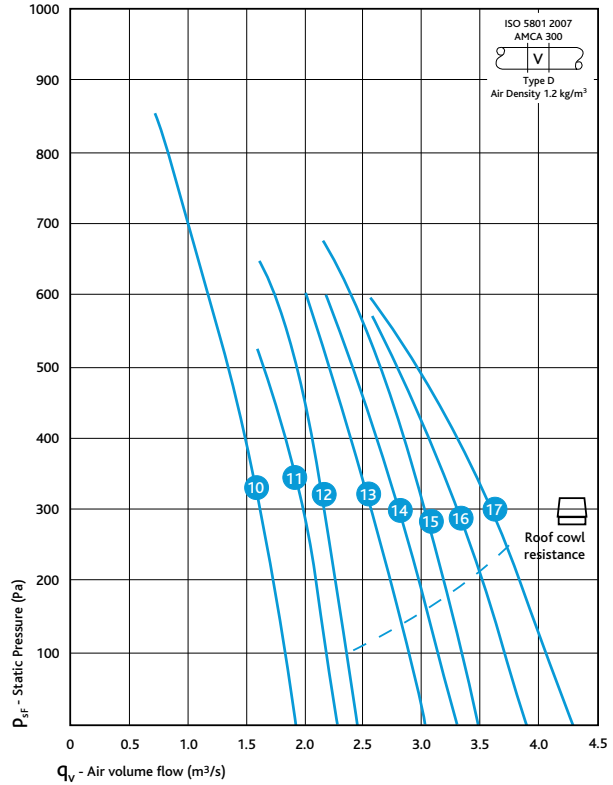

NOTE: THE CURVES ABOVE ARE INDICATIVE OF THE RANGE, A MORE COMPREHENSIVE SELECTION IS AVAILABLE, PLEASE CONTACT NUAIRE TECHNICAL, OR OBTAIN A COPY OF OUR FAN SELECTOR PROGRAMME VIA OUR WEBSITE.

ELECTRICAL & SOUND

Curve No	Unit Code	Blade Angle°	Speed RPM	Unit kg	A.V. Set	Motor frame size	3 Phase (400V)			In-duct inlet sound power levels dB re 1pW						Breakout dBA @ 3m	
							Motor kW	FLC amps	SC amps	Octave band mid frequency Hz							
										125	250	500	1K	2K	4K	8K	
450 Ø - 4 Pole/1400 rpm																	
1	AX45S-413A7	20°	1415	34	NAV38	80	0.55	1.5	7.2	82	81	80	75	71	66	58	52
2	AX45P-413A7	20°	1415	32	NAV38	80	0.55	1.5	7.2	79	79	78	74	71	66	58	50
3	AX45S-433A7	30°	1415	34	NAV38	80	0.55	1.5	7.2	83	82	78	75	70	64	57	51
4	AX45S-453A7	35°	1415	34	NAV38	80	0.55	1.5	7.2	83	81	80	78	72	68	61	53
5	AX45S-473A7	40°	1415	34	NAV38	80	0.55	1.5	7.2	85	86	80	78	71	65	59	54
6	AX45S-483A7	45°	1415	37	NAV39	80	0.75	2	9.8	83	84	80	77	69	65	59	55
7	AX45AA-453A7	37.5°	1415	36	NAV39	80	0.55	1.5	7.2	82	79	75	73	68	61	55	49
8	AX45P-473A7	40°	1415	36	NAV39	80	0.75	2	9.8	79	82	73	72	67	62	57	49
9	AX45P-483A7	45°	1415	36	NAV39	80	0.75	2	9.8	80	81	73	71	66	60	55	49
450 Ø - 2 Pole/2800rpm																	
10	AX45P-213A7	20°	2875	42	NAV39	90	1.8	3.6	31	85	86	91	91	87	83	81	64
11	AX45AA-213A7	32.5°	2875	54	NAV41	100	3	5.8	53	90	87	91	89	85	81	79	64
12	AX45S-253A7	35°	2910	55	NAV41	112	4	7.8	66	91	91	95	94	90	86	82	68
13	AX45P-243A7	32.5°	2910	53	NAV41	112	4	7.8	66	88	86	91	90	87	82	79	65
14	AX45P-253A7	35°	2910	53	NAV41	112	4	7.8	66	89	87	91	91	85	81	78	65
15	AX45AA-253A7	37.5°	2910	56	NAV41	112	4	7.8	66	92	89	92	90	85	80	74	66
16	AX45F-243A7	45°	2910	51	NAV41	112	4	7.8	66	85	82	93	89	85	81	78	65
17	AX45F-253A7	45°	2910	51	NAV41	112	4	7.8	66	87	84	92	90	86	82	79	66

Notes relating to the table: The electrical and sound information in the table is **nominal**. Breakout dBA@3m is spherical, free field. Start currents (sc.) are for DOL starting.

See page 360 for further details on ancillaries.

PERFORMANCE - AXUS LONG CASED AXIAL UNITS - 500MM Ø (300°C FOR 2 HOURS)

500mm Ø 4 Pole/1440 RPM

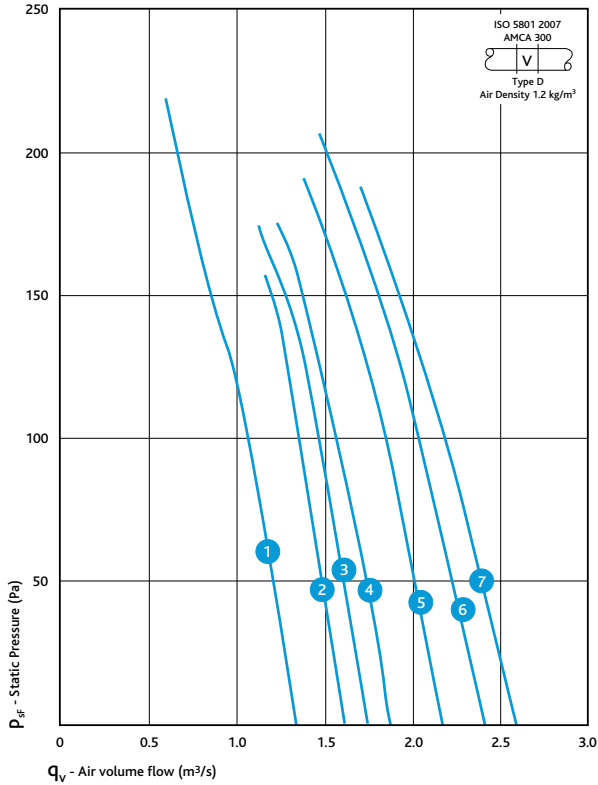

500mm Ø 2 Pole/2800 RPM

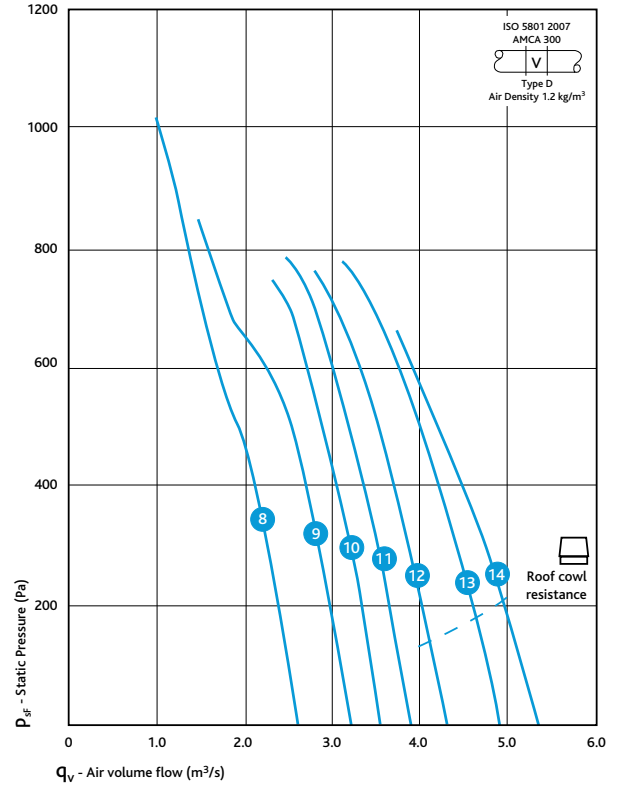

NOTE: THE CURVES ABOVE ARE INDICATIVE OF THE RANGE, A MORE COMPREHENSIVE SELECTION IS AVAILABLE, PLEASE CONTACT NUAIRE TECHNICAL, OR OBTAIN A COPY OF OUR FAN SELECTOR PROGRAMME VIA OUR WEBSITE.

ELECTRICAL & SOUND

Curve No	Unit Code	Blade Angle ^o	Speed RPM	Unit kg	A.V. Set	Motor frame size	3 Phase (400V)			In-duct inlet sound power levels dB re 1pW						Breakout dBA @ 3m	
							Motor kW	FLC amps	SC amps	Octave band mid frequency Hz							
										125	250	500	1K	2K	4K	8K	
500 Ø - 4 Pole/1440 rpm																	
1	AX50P-413A7	20 ^o	1415	33	NAV38	80	0.55	1.5	7.2	79	80	81	77	73	68	60	53
2	AX50S-433A7	30 ^o	1415	35	NAV38	80	0.55	1.5	7.2	80	82	79	77	73	68	62	52
3	AX50S-443A7	32.5 ^o	1415	40	NAV39	80	0.75	2	9.8	81	87	79	78	73	68	61	53
4	AX50S-453A7	35 ^o	1415	40	NAV39	80	0.75	2	9.8	81	84	80	78	73	68	61	53
5	AX50S-473A7	40 ^o	1430	44	NAV39	90	1.1	2.5	14.3	85	84	78	77	70	65	60	53
6	AX50P-473A7	40 ^o	1430	42	NAV39	90	1.1	2.5	14.3	79	80	77	74	70	64	60	52
7	AX50P-483A7	45 ^o	1430	42	NAV39	90	1.1	2.5	14.3	79	80	77	74	69	63	59	52
500 Ø - 2 Pole/2800rpm																	
8	AX50P-213A7	20 ^o	2875	53	NAV41	100	3	5.8	53	87	87	93	95	92	87	85	67
9	AX50P-223A7	25 ^o	2910	58	NAV41	112	4	7.8	66	86	90	96	95	92	86	81	68
10	AX50S-243A7	32.5 ^o	2930	77	NAV43	132	7.5	14	118	93	94	96	94	89	85	81	69
11	AX50S-253A7	35 ^o	2930	77	NAV43	132	7.5	14	118	93	91	99	95	91	87	85	71
12	AX50S-273A7	40 ^o	2935	88	NAV43	132	9	16.6	146	95	93	97	97	92	88	86	71
13	AX50P-263A7	40 ^o	2930	75	NAV43	132	7.5	14	118	91	90	98	94	92	85	82	70
14	AX50P-283A7	45 ^o	2935	85	NAV43	132	9	16.6	146	93	91	99	95	91	86	85	71

Notes relating to the table: The electrical and sound information in the table is **nominal**. Breakout dBA@3m is spherical, free field. Start currents (sc.) are for DOL starting.

See page 360 for further details on ancillaries.

SMOKE FANS

AXUS HIGH TEMPERATURE AXIAL FANS

TECHNICAL INFORMATION

PERFORMANCE - AXUS LONG CASED AXIAL UNITS - 560MM Ø (300°C FOR 2 HOURS)

560mm Ø 4 Pole/1440 RPM

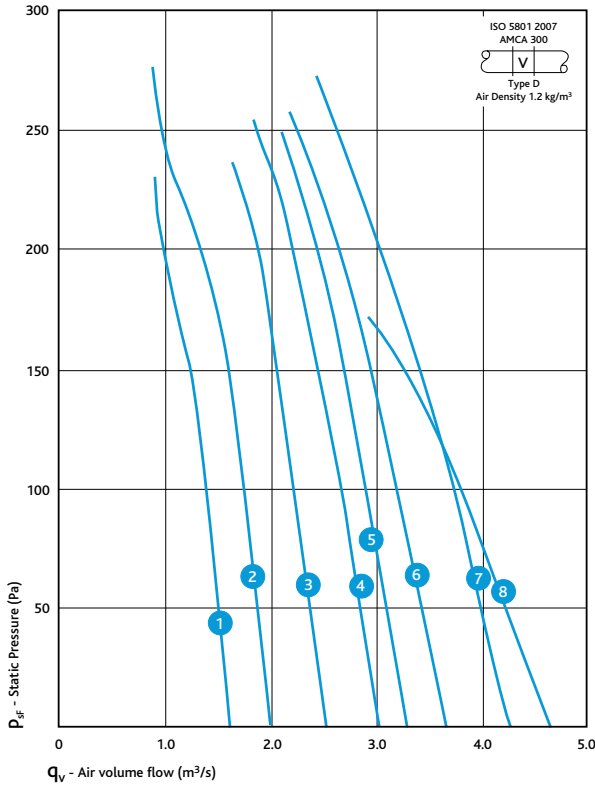

560mm Ø 2 Pole/2800 RPM

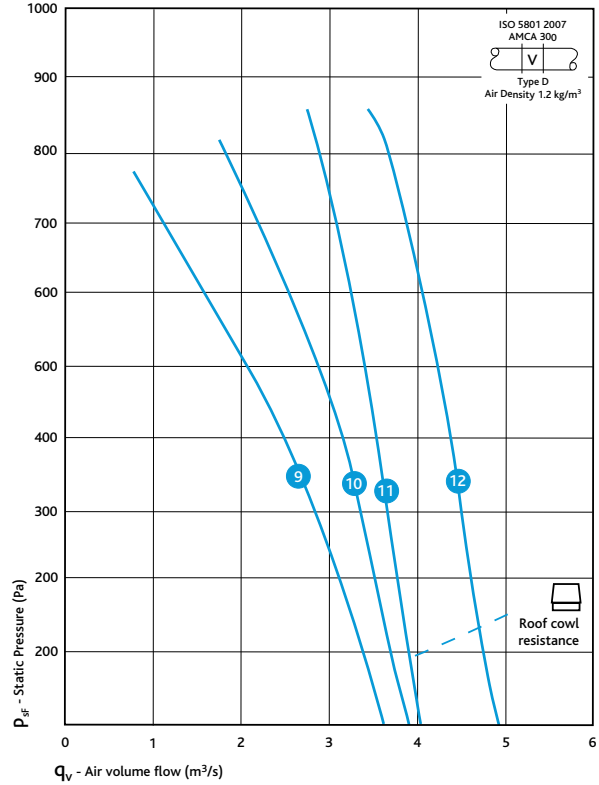

NOTE: THE CURVES ABOVE ARE INDICATIVE OF THE RANGE, A MORE COMPREHENSIVE SELECTION IS AVAILABLE, PLEASE CONTACT NUAIRE TECHNICAL, OR OBTAIN A COPY OF OUR FAN SELECTOR PROGRAMME VIA OUR WEBSITE.

ELECTRICAL & SOUND

Curve No	Unit Code	Blade Angle ^o	Speed RPM	Unit kg	A.V. Set	Motor frame size	3 Phase (400V)			In-duct inlet sound power levels dB re 1pW							Breakout dBA @ 3m	
							Motor kW	FLC amps	SC amps	Octave band mid frequency Hz								
										125	250	500	1K	2K	4K	8K		
560 Ø - 4 Pole/1440 rpm																		
1	AX56S-413A7	20 ^o	1415	41	NAV39	80	0.75	2	9.8	74	72	80	79	77	74	73	55	
2	AX56S-423A7	25 ^o	1415	41	NAV39	80	0.75	2	9.8	75	73	81	80	78	75	74	55	
3	AX56S-433A7	30 ^o	1430	43	NAV39	90	1.1	2.5	14.3	78	76	82	81	78	75	73	56	
4	AX56S-453A7	35 ^o	1435	47	NAV40	90	1.5	3.4	19.7	80	79	83	80	76	72	68	56	
5	AX56S-473A7	40 ^o	1435	47	NAV40	90	1.5	3.4	19.7	85	84	84	80	76	72	67	55	
6	AX56S-483A7	45 ^o	1435	49	NAV40	90	1.8	4	24.4	83	87	83	81	77	74	68	55	
7	AX56AA-473A7	45 ^o	1435	49	NAV40	90	1.8	4	24.4	83	82	82	79	74	70	66	53	
8	AX56X-483A7	50 ^o	1435	44	NAV40	90	1.5	3.4	19.7	87	79	80	77	71	66	63	52	
560 Ø - 2 Pole/2800rpm																		
9	AX56D-213A7	25 ^o	2875	42	NAV39	90	1.8	3.6	31.3	83	79	88	91	89	87	86	66	
10	AX56F-213A7	25 ^o	2875	49	NAV40	100	3	5.8	53	86	82	89	89	90	88	87	65	
11	AX56S-223A7	25 ^o	2930	94	NAV44	132	7.5	14	118	90	89	97	96	94	91	89	70	
12	AX56S-233A7	30 ^o	2935	102	NAV44	132	9	16.6	146	97	93	99	97	92	89	84	70	

Notes relating to the table: The electrical and sound information in the table is **nominal**. Breakout dBA@3m is spherical, free field. Start currents (sc.) are for DOL starting.

See page 360 for further details on ancillaries.

PERFORMANCE - AXUS LONG CASED AXIAL UNITS - 630MM Ø (300°C FOR 2 HOURS)

630mm Ø 4 Pole/1440 RPM

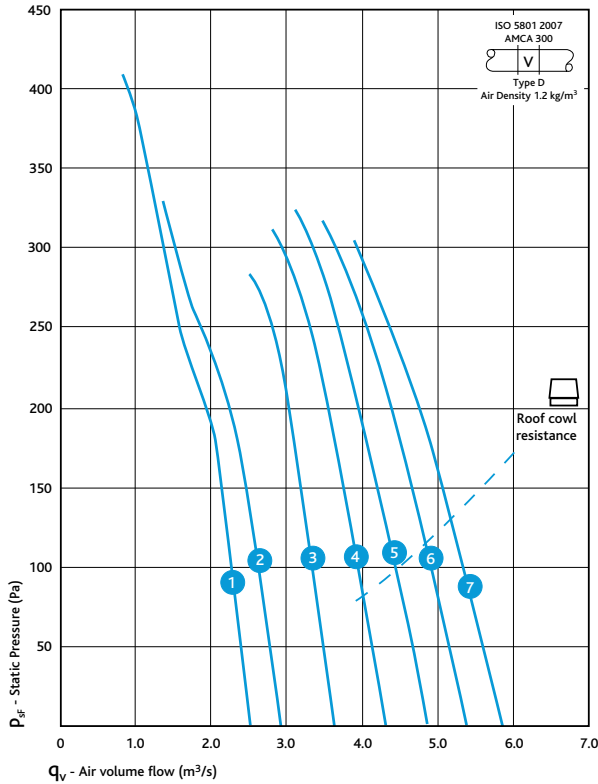

630mm Ø 2 Pole/2800 RPM

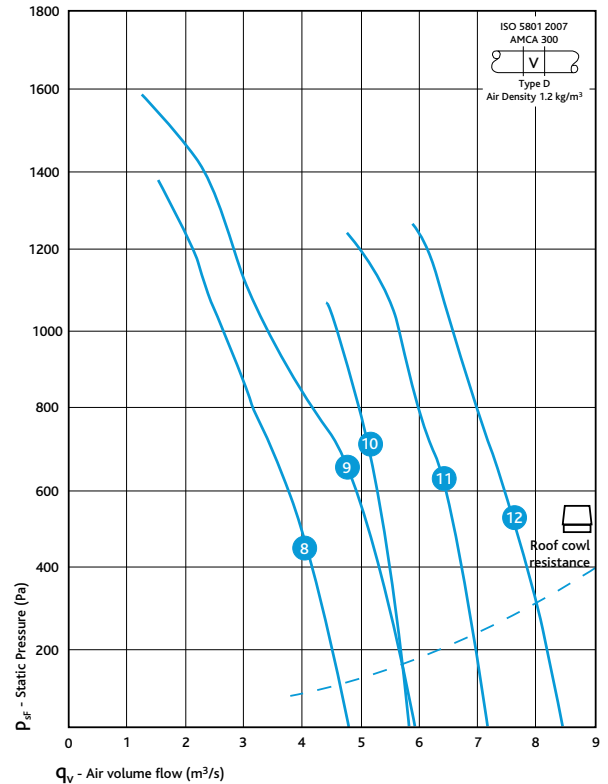

NOTE: THE CURVES ABOVE ARE INDICATIVE OF THE RANGE, A MORE COMPREHENSIVE SELECTION IS AVAILABLE, PLEASE CONTACT NUAIRE TECHNICAL, OR OBTAIN A COPY OF OUR FAN SELECTOR PROGRAMME VIA OUR WEBSITE.

ELECTRICAL & SOUND

Curve No	Unit Code	Blade Angle°	Speed RPM	Unit kg	A.V. Set	Motor frame size	3 Phase (400V)			In-duct inlet sound power levels dB re 1pW						Breakout dBA @ 3m	
							Motor kW	FLC amps	SC amps	Octave band mid frequency Hz							
										125	250	500	1K	2K	4K	8K	
630 Ø - 4 Pole/1440 rpm																	
1	AX63S-413A7	20°	1430	50	NAV40	90	1.1	2.5	14.3	85	85	83	81	78	76	68	56
2	AX63S-423A7	25°	1430	50	NAV40	90	1.1	2.5	14.3	82	82	83	80	77	75	67	55
3	AX63AD-423A7	30°	1435	56	NAV41	100	1.8	4	24.4	85	87	86	80	76	72	64	57
4	AX63AD-443A7	35°	1435	59	NAV41	100	2.2	4.7	30.1	85	90	85	81	78	76	68	58
5	AX63AD-473A7	45°	1435	61	NAV41	100	3	6.4	41	87	87	84	81	77	73	67	58
6	AX63AD-483A7	50°	1455	65	NAV41	112	4	8.2	57	86	87	86	82	78	74	68	59
7	AX63AA-483A7	50°	1455	63	NAV41	112	4	8.2	57	83	87	85	82	77	71	67	58
630 Ø - 2 Pole/2800rpm																	
8	AX63P-213A7	20°	2915	81	NAV43	132	5.5	10.3	100	86	89	97	99	98	92	90	72
9	AX63P-223A7	25°	2935	88	NAV43	132	9	16.6	146	94	93	102	101	98	93	90	74
10	AX63AD-213A7	25°	2935	123	NAV46	160	11	19.9	183	92	92	100	99	96	92	93	73
11	AX63AD-223A7	30°	2940	141	NAV46	160	15	27	265	95	94	105	98	95	91	91	75
12	AX63AD-243A7	35°	2938	156	NAV47	180	22	39.9	319	97	97	107	100	95	92	91	77

Notes relating to the table: The electrical and sound information in the table is **nominal**. Breakout dBA@3m is spherical, free field. Start currents (sc.) are for DOL starting.

See page 360 for further details on ancillaries.

SMOKE FANS

AXUS HIGH TEMPERATURE AXIAL FANS

TECHNICAL INFORMATION

PERFORMANCE - AXUS LONG CASED AXIAL UNITS - 710MM Ø (300°C FOR 2 HOURS)

710mm Ø 6 Pole/960 RPM

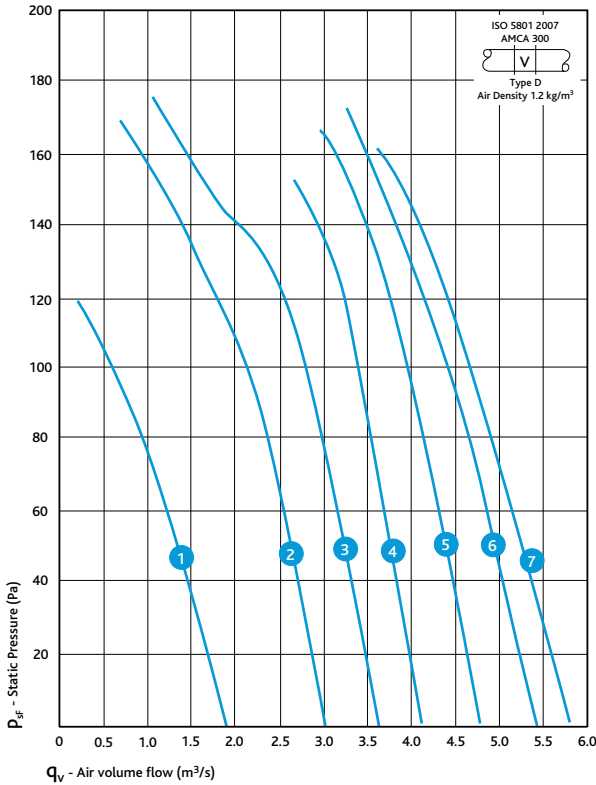

710mm Ø 4 Pole/1400 RPM

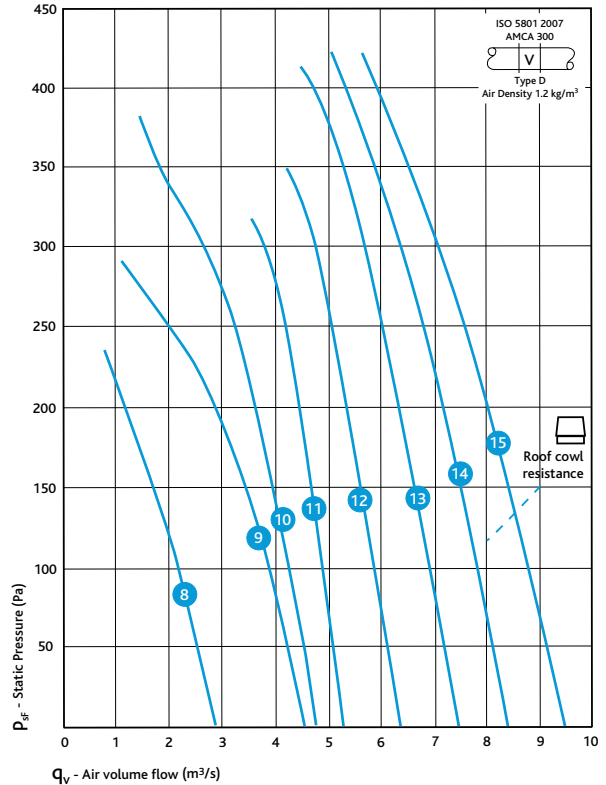

NOTE: THE CURVES ABOVE ARE INDICATIVE OF THE RANGE, A MORE COMPREHENSIVE SELECTION IS AVAILABLE, PLEASE CONTACT NUAIRE TECHNICAL, OR OBTAIN A COPY OF OUR FAN SELECTOR PROGRAMME VIA OUR WEBSITE.

ELECTRICAL & SOUND

Curve No	Unit Code	Blade Angle°	Speed RPM	Unit kg	A.V. Set	Motor frame size	3 Phase (400V)			In-duct inlet sound power levels dB re 1pW						Breakout dBA @ 3m	
							Motor kW	FLC amps	SC amps	Octave band mid frequency Hz							
										125	250	500	1K	2K	4K	8K	
710 Ø - 6 Pole/960 rpm																	
1	AX71O-613A7	20°	920	43	NAV39	90	0.55	1.75	8.1	78	79	76	76	72	66	57	49
2	AX71P-623A7	25°	920	45	NAV39	90	0.55	1.75	8.1	82	76	74	74	72	67	58	49
3	AX71AA-623A7	30°	920	47	NAV40	90	0.55	1.75	8.1	83	78	74	74	73	65	56	49
4	AX71AD-643A7	35°	920	57	NAV41	90	1.1	3.0	13.3	79	79	77	73	70	64	58	50
5	AX71AD-663A7	40°	920	61	NAV41	100	1.5	4	19.2	81	79	77	73	70	65	60	50
6	AX71AD-673A7	45°	920	61	NAV41	100	1.5	4	19.2	79	78	78	73	70	65	61	51
7	AX71AD-683A7	30°	960	66	NAV42	112	2.2	5.2	31.7	79	81	79	75	72	67	61	52
710 Ø - 4 Pole/1400 rpm																	
8	AX71O-413A7	20°	1415	44	NAV39	80	0.75	2	9.8	83	82	84	85	81	78	72	57
9	AX71O-423A7	25°	1430	45	NAV39	90	1.1	2.5	14.3	81	81	80	80	79	77	70	56
10	AX71P-423A7	25°	1435	48	NAV40	100	1.8	4	24.4	100	95	90	86	81	79	72	61
11	AX71AD-423A7	30°	1435	63	NAV41	100	3	6.4	41	83	92	88	86	83	81	72	60
12	AX71AA-463A7	40°	1455	64	NAV41	112	4	8.2	57	83	95	89	86	83	81	73	63
13	AX71AD-463A7	40°	1455	97	NAV44	132	5.5	10.8	81	86	91	86	83	80	75	69	60
14	AX71AD-473A7	45°	1455	97	NAV44	132	5.5	10.8	81	85	96	87	85	80	75	70	62
15	AX71AD-483A7	50°	1455	124	NAV46	132	7.5	14.5	107	86	94	90	87	84	80	76	64

Notes relating to the table: The electrical and sound information in the table is **nominal**. Breakout dBA@3m is spherical, free field. Start currents (sc.) are for DOL starting.

See page 360 for further details on ancillaries.

PERFORMANCE - AXUS LONG CASED AXIAL UNITS - 800MM Ø (300°C FOR 2 HOURS)

800mm Ø 6 Pole/960 RPM

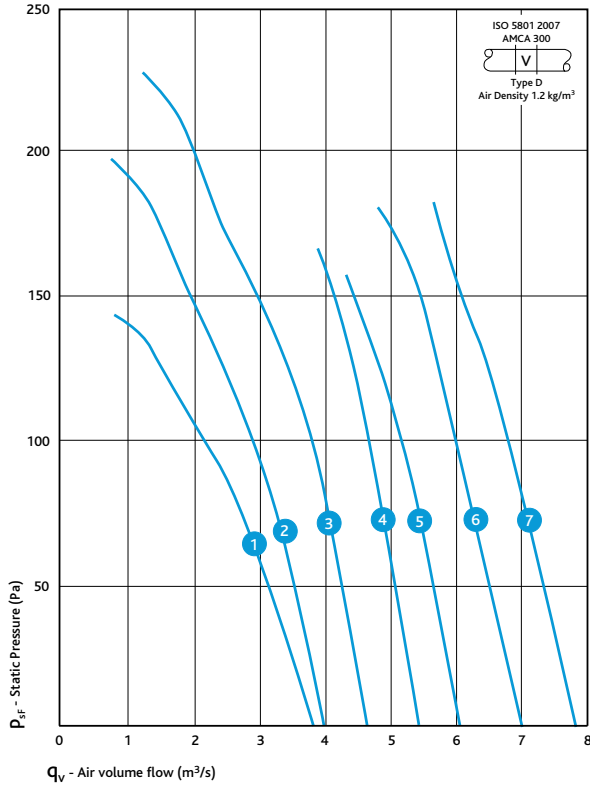

800mm Ø 4 Pole/1400 RPM

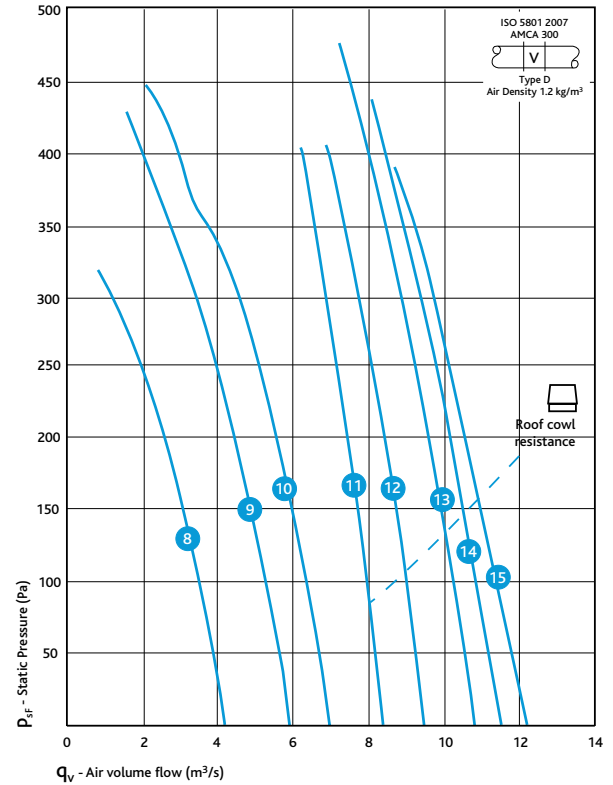

NOTE: THE CURVES ABOVE ARE INDICATIVE OF THE RANGE, A MORE COMPREHENSIVE SELECTION IS AVAILABLE, PLEASE CONTACT NUAIRE TECHNICAL, OR OBTAIN A COPY OF OUR FAN SELECTOR PROGRAMME VIA OUR WEBSITE.

ELECTRICAL & SOUND

Curve No	Unit Code	Blade Angle ^o	Speed RPM	Unit kg	A.V. Set	Motor frame size	3 Phase (400V)			In-duct inlet sound power levels dB re 1pW						Breakout dBA @ 3m	
							Motor kW	FLC amps	SC amps	Octave band mid frequency Hz							
										125	250	500	1K	2K	4K	8K	
800 Ø - 6 Pole/960 rpm																	
1	AX80O-623A7	25°	920	57	NAV41	90	0.55	1.75	8.1	80	76	76	77	75	71	60	50
2	AX80P-623A7	25°	920	59	NAV41	90	0.55	1.75	8.1	82	75	77	76	75	71	60	50
3	AX80AG-623A7	30°	920	87	NAV43	100	1.5	4	19.2	82	85	83	79	78	72	63	56
4	AX80AG-643A7	35°	960	100	NAV44	112	2.2	5.2	31.7	80	86	81	79	78	74	66	55
5	AX80AG-663A7	40°	960	100	NAV44	112	2.2	5.2	31.7	81	84	81	78	76	72	64	55
6	AX80AG-673A7	45°	945	125	NAV46	132	3	7	39.2	84	86	83	79	76	71	66	58
7	AX80AG-683A7	50°	945	135	NAV46	132	4	9.3	52	83	88	84	81	78	74	68	57
800 Ø - 4 Pole/1440 rpm																	
8	AX80O-413A7	20°	1430	57	NAV41	90	1.1	2.5	14.3	83	84	86	91	88	82	76	62
9	AX80P-423A7	25°	1435	63	NAV41	100	2.2	4.7	30.1	80	86	87	87	85	84	78	61
10	AX80AA-423A7	30°	1435	69	NAV42	100	3	6.4	41	82	88	88	86	83	82	74	61
11	AX80AG-443A7	35°	1455	134	NAV46	132	7.5	14.5	107	87	89	92	90	87	85	79	64
12	AX80AG-463A7	40°	1455	149	NAV46	160	11	21.2	163	89	94	94	89	86	84	78	64
13	AX80AG-473A7	45°	1455	149	NAV46	160	11	21.2	163	91	93	93	89	85	82	77	66
14	AX80AG-483A7	50°	1456	159	NAV47	160	15	28.8	202	93	93	96	91	89	85	82	68
15	AX80AD-483A7	50°	1455	145	NAV46	160	11	21.2	163	88	96	92	89	87	84	81	65

Notes relating to the table: The electrical and sound information in the table is **nominal**. Breakout dBA@3m is spherical, free field. Start currents (sc.) are for DOL starting.

See page 360 for further details on ancillaries.

SMOKE FANS

AXUS HIGH TEMPERATURE AXIAL FANS

TECHNICAL INFORMATION

PERFORMANCE - AXUS LONG CASED AXIAL UNITS - 900MM Ø (300°C FOR 2 HOURS)

900mm Ø 6 Pole/960 RPM

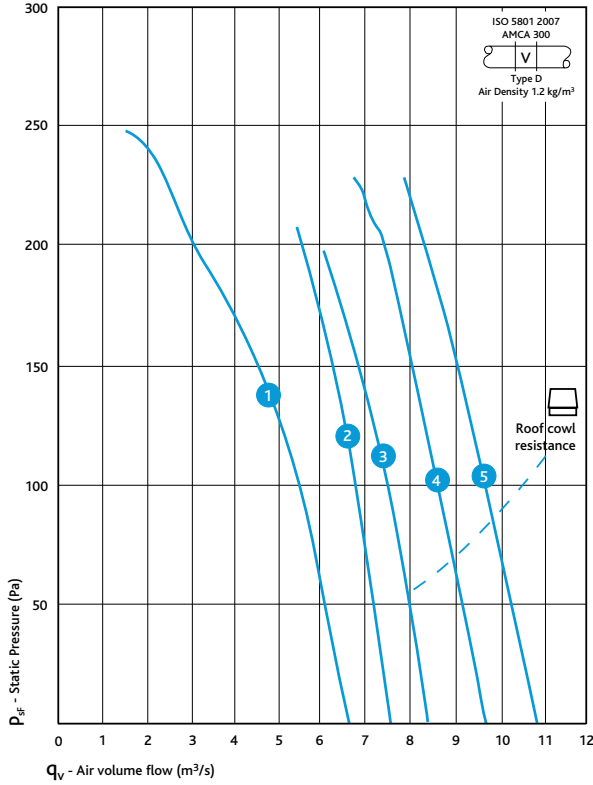

900mm Ø 4 Pole/1400 RPM

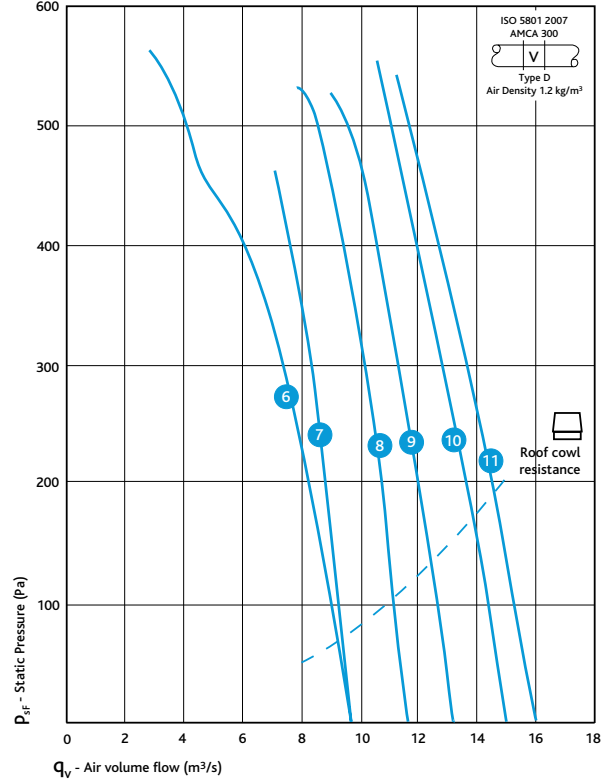

NOTE: THE CURVES ABOVE ARE INDICATIVE OF THE RANGE, A MORE COMPREHENSIVE SELECTION IS AVAILABLE, PLEASE CONTACT NUAIRE TECHNICAL, OR OBTAIN A COPY OF OUR FAN SELECTOR PROGRAMME VIA OUR WEBSITE.

ELECTRICAL & SOUND

Curve No	Unit Code	Blade Angle ^o	Speed RPM	Unit kg	A.V. Set	Motor frame size	3 Phase (400V)			In-duct inlet sound power levels dB re 1pW						Breakout dBA @ 3m	
							Motor kW	FLC amps	SC amps	Octave band mid frequency Hz							
										125	250	500	1K	2K	4K	8K	
900 Ø - 6 Pole/960 rpm																	
1	AX90AA-623A7	30 ^o	920	102	NAV44	100	1.5	4	19.2	85	82	80	79	79	74	61	54
2	AX90AG-643A7	35 ^o	945	144	NAV46	132	4	9.3	52	83	90	85	83	82	78	69	60
3	AX90AG-663A7	40 ^o	945	144	NAV46	132	4	9.3	52	84	88	84	81	80	75	68	58
4	AX90AG-673A7	45 ^o	950	149	NAV46	132	5.5	12.7	72	88	90	87	83	79	75	69	62
5	AX90AG-683A7	50 ^o	970	174	NAV47	160	7.5	16.1	76	87	92	88	85	82	78	72	61
900 Ø - 4 Pole/1440 rpm																	
6	AX90AA-423A7	30 ^o	1455	120	NAV45	132	5.5	10.8	81	85	92	92	90	86	85	78	71
7	AX90AG-423A7	30 ^o	1455	163	NAV47	160	11	21.2	163	90	94	96	92	89	89	81	69
8	AX90AG-443A7	35 ^o	1456	173	NAV47	160	15	28.8	202	90	93	96	93	90	89	82	69
9	AX90AG-463A7	40 ^o	1456	187	NAV47	180	18.5	35.2	268	92	97	97	93	90	88	82	69
10	AX90AG-473A7	45 ^o	1456	203	NAV47	180	22	41.7	329	94	96	97	93	89	85	81	70
11	AX90AG-483A7	50 ^o	1450	256	NAV48	200	30	56.3	372	97	97	99	95	92	88	85	71

Notes relating to the table: The electrical and sound information in the table is **nominal**. Breakout dBA@3m is spherical, free field. Start currents (sc.) are for DOL starting.

See page 360 for further details on ancillaries.

PERFORMANCE - AXUS LONG CASED AXIAL UNITS - 1000MM Ø (300°C FOR 2 HOURS)

1000mm Ø 6 Pole/960 RPM

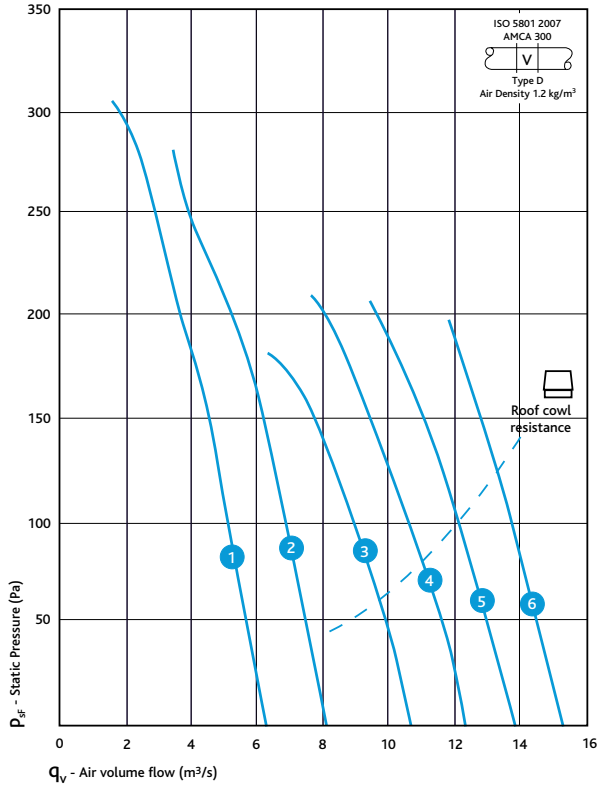

1000mm Ø 4 Pole/1400 RPM

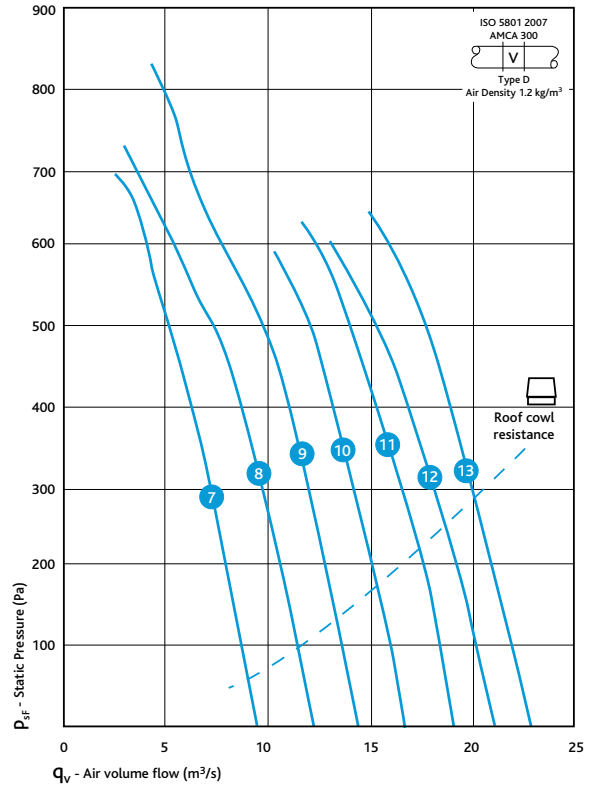

NOTE: THE CURVES ABOVE ARE INDICATIVE OF THE RANGE, A MORE COMPREHENSIVE SELECTION IS AVAILABLE, PLEASE CONTACT NUAIRE TECHNICAL, OR OBTAIN A COPY OF OUR FAN SELECTOR PROGRAMME VIA OUR WEBSITE.

ELECTRICAL & SOUND

Curve No	Unit Code	Blade Angle°	Speed RPM	Unit kg	A.V. Set	Motor frame size	3 Phase (400V)			In-duct inlet sound power levels dB re 1pW						Breakout dBA @ 3m	
							Motor kW	FLC amps	SC amps	Octave band mid frequency Hz							
										125	250	500	1K	2K	4K	8K	
1000 Ø - 6 Pole/960 rpm																	
1	AX100AD-613A7	25°	960	115	NAV45	112	2.2	5.2	31.7	83	89	94	93	85	81	67	64
2	AX100AD-623A7	30°	945	127	NAV46	132	3	7	39.2	93	88	95	95	89	83	73	66
3	AX100CX-623A7	30°	950	161	NAV47	132	5.5	12.7	72	100	94	89	82	77	74	67	63
4	AX100CX-643A7	35°	970	190	NAV47	160	7.5	16.1	76	94	89	85	80	76	77	71	60
5	AX100CX-663A7	40°	970	214	NAV47	160	11	23.3	107	95	90	87	82	78	79	74	61
6	AX100CX-673A7	45°	970	214	NAV47	160	11	23.3	107	100	91	86	83	79	78	75	62
1000 Ø - 4 Pole/1400 rpm																	
7	AX100AD-413A7	25°	1455	103	NAV44	132	5.5	10.8	81	84	97	94	100	96	91	86	71
8	AX100AD-423A7	25°	1455	129	NAV46	160	11	21.2	163	96	98	103	103	98	92	87	74
9	AX100CX-413A7	30°	1455	179	NAV47	160	11	21.2	163	97	96	97	93	89	88	81	69
10	AX100CX-423A7	35°	1456	187	NAV47	160	15	28.8	202	102	98	97	94	90	88	83	70
11	AX100CX-443A7	35°	1456	221	NAV47	180	22	41.7	329	100	100	98	95	91	90	87	71
12	AX100CX-463A7	40°	1460	319	NAV49	200	30	56	372	101	101	100	97	93	92	89	73
13	AX100CX-473A7	45°	1468	359	NAV49	225	37	69	433	103	101	100	98	95	95	93	73

Notes relating to the table: The electrical and sound information in the table is **nominal**. Breakout dBA@3m is spherical, free field. Start currents (sc.) are for DOL starting.

See page 360 for further details on ancillaries.

SMOKE FANS

AXUS HIGH TEMPERATURE AXIAL FANS

TECHNICAL INFORMATION

PERFORMANCE - AXUS LONG CASED AXIAL UNITS - 1120MM Ø (300°C FOR 2 HOURS)

1120mm Ø 6 Pole/960 RPM

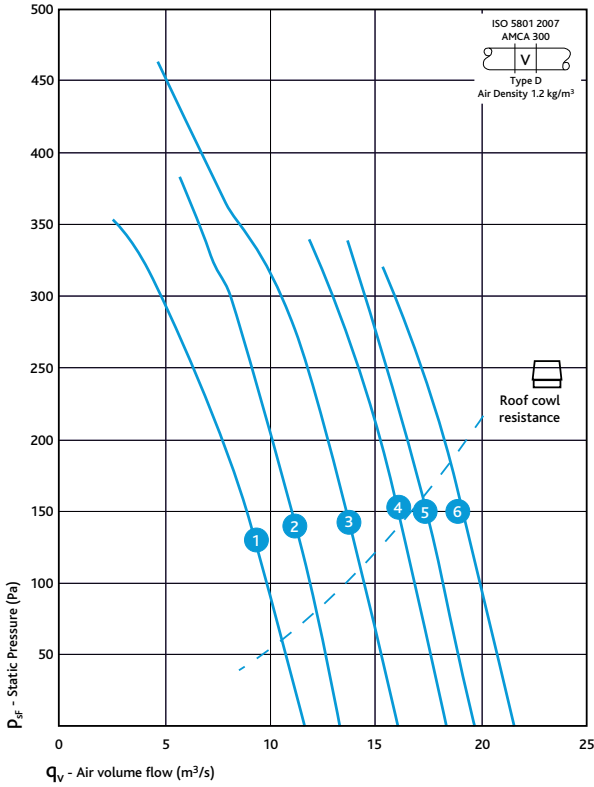

1120mm Ø 4 Pole/1400 RPM

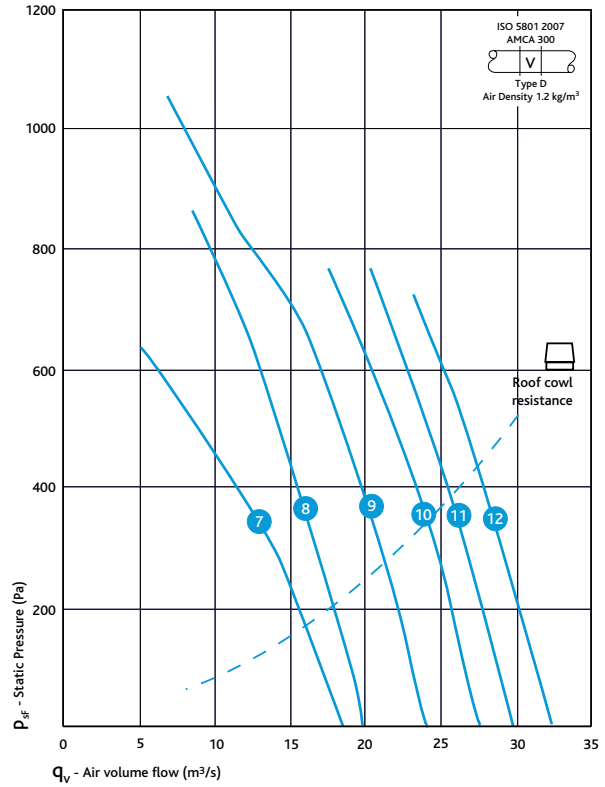

NOTE: THE CURVES ABOVE ARE INDICATIVE OF THE RANGE, A MORE COMPREHENSIVE SELECTION IS AVAILABLE, PLEASE CONTACT NUAIRE TECHNICAL, OR OBTAIN A COPY OF OUR FAN SELECTOR PROGRAMME VIA OUR WEBSITE.

ELECTRICAL & SOUND

Curve No	Unit Code	Blade Angle°	Speed RPM	Unit kg	A.V. Set	Motor frame size	3 Phase (400V)			In-duct inlet sound power levels dB re 1pW						Breakout dBA @ 3m	
							Motor kW	FLC amps	SC amps	Octave band mid frequency Hz							
										125	250	500	1K	2K	4K	8K	
1120 Ø - 6 Pole/960 rpm																	
1	AX112CW-613A7	25°	945	196	NAV47	132	3	7	43	91	95	94	95	88	83	74	69
2	AX112CX-613A7	25°	950	212	NAV47	132	5.5	12.7	72	94	93	88	85	81	80	82	67
3	AX112CX-623A7	30°	970	228	NAV47	160	7.5	16.1	76	98	94	89	86	83	80	79	68
4	AX112CX-643A7	35°	970	252	NAV48	160	11	23.3	107	99	96	91	87	85	83	79	69
5	AX112CX-663A7	40°	970	252	NAV48	160	11	23.3	107	101	98	94	89	87	86	83	72
6	AX112CX-673A7	45°	970	293	NAV48	180	15	30.1	205	104	100	95	91	89	88	86	73
1120 Ø - 4 Pole/1440 rpm																	
7	AX112CW-413A7	25°	1455	222	NAV47	160	11	21.2	163	95	101	105	104	98	92	85	77
8	AX112CX-413A7	25°	1455	233	NAV47	160	15	28.8	202	98	99	99	94	92	88	93	75
9	AX112CX-423A7	30°	1455	270	NAV48	180	22	41.7	329	102	100	100	95	94	89	90	76
10	AX112CX-443A7	35°	1460	323	NAV49	200	30	56.3	372	103	102	102	96	95	92	90	77
11	AX112CX-463A7	40°	1470	369	NAV49	225	37	69	433	105	104	105	98	98	95	94	80
12	AX112CX-473A7	45°	1480	531	NAV51	250	55	101	707	108	106	106	100	100	97	97	81

Notes relating to the table: The electrical and sound information in the table is **nominal**. Breakout dBA@3m is spherical, free field. Start currents (sc.) are for DOL starting.

See page 360 for further details on ancillaries.

PERFORMANCE - AXUS LONG CASED AXIAL UNITS - 1250MM Ø (300°C FOR 2 HOURS)

1250mm Ø 6 Pole/960 RPM

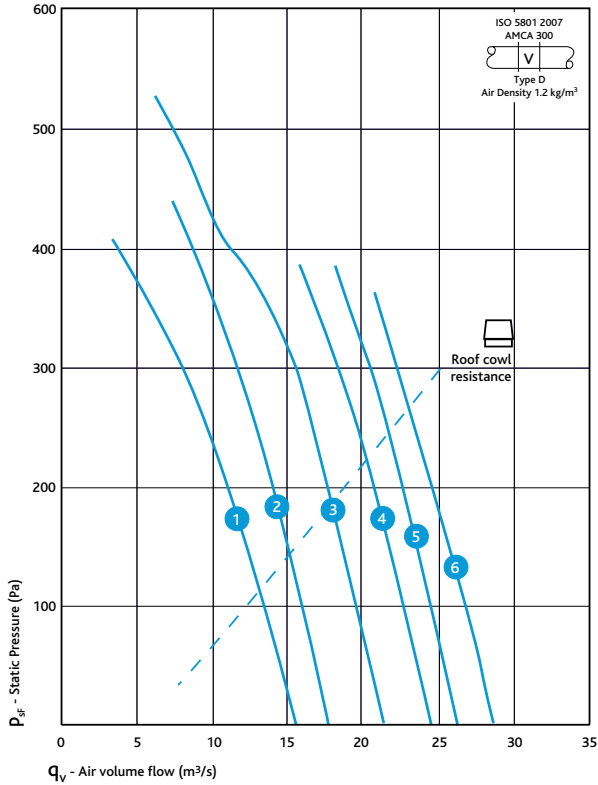

1250mm Ø 4 Pole/1400 RPM

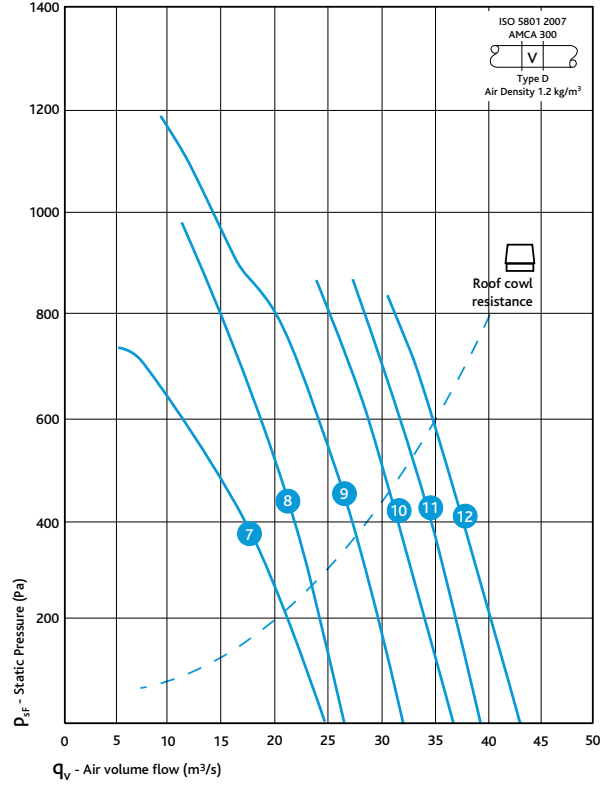

NOTE: THE CURVES ABOVE ARE INDICATIVE OF THE RANGE, A MORE COMPREHENSIVE SELECTION IS AVAILABLE, PLEASE CONTACT NUAIRE TECHNICAL, OR OBTAIN A COPY OF OUR FAN SELECTOR PROGRAMME VIA OUR WEBSITE.

ELECTRICAL & SOUND

Curve No	Unit Code	Blade Angle°	Speed RPM	Unit kg	A.V. Set	Motor frame size	3 Phase (400V)			In-duct inlet sound power levels dB re 1pW Octave band mid frequency Hz						Breakout dBA @ 3m	
							Motor kW	FLC amps	SC amps	125	250	500	1K	2K	4K		8K
1250 Ø - 6 Pole/960 rpm																	
1	AX125CW-613A7	25°	945	245	NAV48	132	4	9.3	52	95	99	100	99	9487	80	73	73
2	AX125CX-613A7	25°	970	257	NAV48	160	7.5	16.1	76	95	96	91	88	84	83	85	70
3	AX125CX-623A7	30°	970	281	NAV48	160	11	23.3	107	99	97	92	89	86	83	82	71
4	AX125CX-643A7	35°	970	311	NAV48	180	15	30.1	205	100	99	94	90	88	86	82	72
5	AX125CX-663A7	40°	970	347	NAV49	200	18.5	37	237	102	101	97	92	90	89	86	75
6	AX125CX-673A7	45°	970	377	NAV49	200	22	43.6	262	105	103	98	94	92	91	89	76
1250 Ø - 4 Pole/1440 rpm																	
7	AX125CW-413A7	25°	1460	245	NAV48	160	15	28.8	202	99	105	109	108	102	96	89	81
8	AX125CX-413A7	25°	1460	289	NAV48	180	22	41.7	329	99	102	100	97	93	91	94	78
9	AX125CX-423A7	30°	1460	353	NAV49	200	30	56	372	103	103	101	98	95	92	91	79
10	AX125CX-443A7	35°	1470	423	NAV50	225	45	83	525	104	105	103	99	96	95	91	80
11	AX125CX-463A7	40°	1480	619	NAV53	250	55	101	707	106	107	106	101	99	98	95	83
12	AX125CX-473A7	45°	1480	724	NAV54	280	75	137	986	109	109	107	103	101	100	98	84

Notes relating to the table: The electrical and sound information in the table is **nominal**. Breakout dBA@3m is spherical, free field. Start currents (sc.) are for DOL starting.

See page 360 for further details on ancillaries.

SMOKE FANS

AXUS HIGH TEMPERATURE AXIAL FANS

TECHNICAL INFORMATION

DIMENSIONS

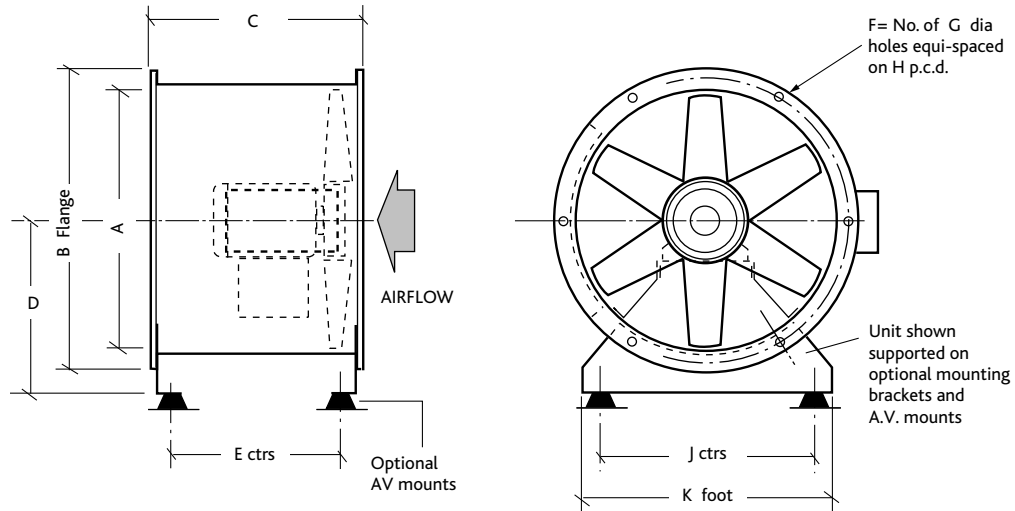

DIMENSIONS (mm) & WEIGHTS









Code	Frame	A	B	C	D	E	F	G	H	J	K	Max. Weight Kg
AX31	80	315	400	365	210	270	8	12	355	220	270	23
AX35	90	350	430	380	240	270	8	12	395	250	300	26
AX40	90-100	400	490	440	270	370	8	12	450	290	340	44
AX45	90-112	450	540	450	300	360	8	12	500	330	380	65
AX45	132	450	540	600	300	520	8	12	500	330	380	65
AX50	90-112	500	608	465	340	360	12	12	560	380	430	88
AX50	132	500	608	615	340	520	12	12	560	380	430	88
AX56	90-100	560	670	440	370	360	12	12	620	420	470	104
AX56	132	560	670	615	370	520	12	12	620	420	470	104
AX63	90-112	630	740	480	430	360	12	12	690	500	550	209
AX63	132-180	630	740	600	430	520	12	12	690	500	550	209
AX63	160-180	630	740	800	430	300	12	12	690	500	550	209
AX71	80-112	710	814	455	470	360	16	12	770	540	600	124
AX71	132	710	814	700	470	620	16	12	770	540	600	124
AX80	90-112	800	910	440	540	360	16	12	860	590	650	142
AX80	132-160	800	910	840	540	620	16	12	860	590	650	142
AX90	112-180	900	1016	740	600	660	16	15	970	670	750	203
AX100	112-180	1000	1128	740	670	630	16	15	1070	770	850	324
AX100	200	1000	1128	850		740	16	15	1070	770	850	324
AX112	132-160	1120	1240	730	750	620	20	15	1190	870	950	551
AX112	180-200	1120	1240	865	750	755	20	15	1190	870	950	551
AX112	225-250	1120	1240	1010	750	900	20	15	1190	870	950	551
AX125	132-200	1250	1365	865	830	755	20	15	1320	920	1000	729
AX125	225-280	1250	1365	1010	830	900	20	15	1320	920	1000	729

Please call Nuair on (029) 2085 8200 if you require further details.

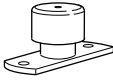
See page 360 for further details on ancillaries.

ANCILLARIES

AXUS HIGH TEMPERATURE AXIAL FANS

Ancillary	Code (mm)	AX31 315	AX35 350	AX40 400	AX45 450	AX50 500	AX56 560	AX63 630	AX71 710	AX80 800	AX90 900	AX100 1000	AX112 1120	AX125 1250
Description														
Mounting Brackets 	Mounting brackets supplied as pair. manufactured from heavy gauge steel.	CMB31	CMB35	CMB40	CMB45	CMB50	CMB56	CMB63	CMB71	CMB80	CMB90	CMB100	CMB112	CMB125
Matching Flange 	Flange supplied as single. Manufactured from galvanised steel.	CMF31	CMF35	CMF40	CMF45	CMF50	CMF56	CMF63	CMF71	CMF80	CMF90	CMF100	CMF112	CMF125
Flexible Connector 	Circular without flange. Flexible duct material is flameproof and heat resistant up to 132°C. The material is airtight and waterproof.	CFCH31	CFCH35	CFCH40	CFCH45	CFCH50	CFCH56	CFCH63	CFCH71	CFCH80	CFCH90	CFCH100	CFCH112	CFCH125
Anti-vibration Mounts 	Resilient rubber, for fan only.	For further details on AV Mounts please contact Nuair												
Attenuator 	Standard, Long, podded & long podded options. CA31LP	CA31S CA31L CA31P CA35LP	CA35S CA35L CA35P CA40LP	CA40S CA40L CA40P CA45LP	CA45S CA45L CA45P CA50LP	CA50S CA50L CA50P CA56LP	CA56S CA56L CA56P CA63LP	CA63S CA63L CA63P CA71LP	CA71S CA71L CA71P CA80LP	CA80S CA80L CA80P CA90LP	CA90S CA90L CA90P CA100LP	CA100S CA100L CA100P CA112LP	CA112S CA112L CA112P CA125LP	CA125S CA125L CA125P
Guard 	Manufactured in heavy gauge galvanised steel with acid zinc plated steel mesh.	CDG31	CDG35	CDG40	CDG45	CDG50	CDG56	CDG63	CDG71	CDG80	CDG90	CDG100	CDG112	CDG125
Inlet Cone 	manufactured in heavy gauge galvanised steel with a single bolted flange.	CIC31	CIC35	CIC40	CIC45	CIC50	CIC56	CIC63	CIC71	CIC80	CIC90	CIC100	CIC112	CIC125
Backdraft Damper 	Gravity operated damper manufactured from heavy gauge galvanised steel with pair of bolted flanges.	CBD31	CBD35	CBD40	CBD45	CBD50	CBD56	CBD63	CBD71	CBD80	CBD90	CBD100	CBD112	CBD125
Roof Cowl 	Manufactured from Aluzinc designed to use with high temperature Axial Fans.	-	-	ARC56	ARC56	ARC71	ARC71	ARC71	ARC100	ARC100	ARC125	ARC125	ARC125	ARC125

See page 360 for further details on ancillaries.

ANCILLARIES FOR AXIAL FANS - DETAILS

Mounting Brackets

The AXUS mounting brackets are manufactured from heavy gauge galvanised steel and are supplied in pairs.

Typical Code: CMB100 (100 = fan diameter in cm).

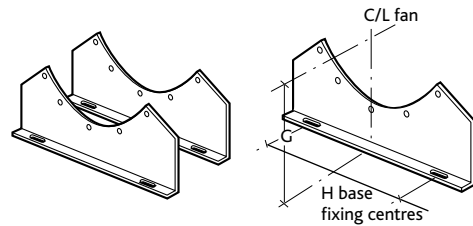

Matching Flange (Single)

Manufactured from galvanised steel matching flanges are supplied individually.

Typical code: CMF100 (100 = fan diameter in cm).

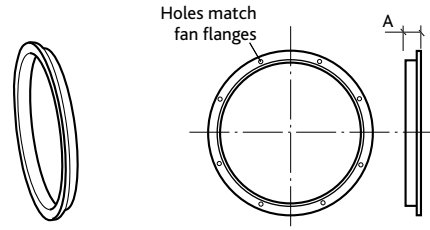

Flexible Connector (Single)

Circular without flanges. Flexible duct material is flameproof and resistant to heat up to 132°C/400°C, chemicals, ozone, oil and grease. The material is airtight, waterproof and tested to BS476 Part 7.

(Supplied complete with fixing straps).

CFCH100 (100 = fan diameter in cm) - 400°C.

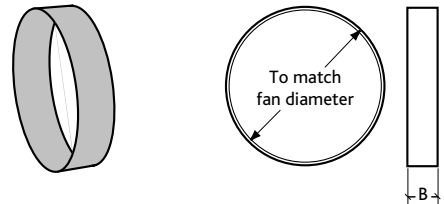

Guard (Single)

Manufactured from heavy gauge galvanised steel and acid zinc plated steel mesh.

Flat type • Finger guard 0.75.

Typical Code: CGD100 (100 = fan diameter in cm)

Pressure Drop (Pa) = 0.6 x k x Velocity (m/s).

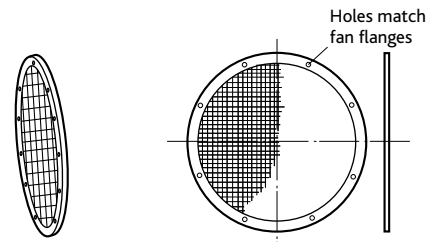

Inlet Cone (Single)

Manufactured in heavy gauge galvanised steel with a single bolted flange.

Standard Accessory Losses (k).

Low loss • inlet cone 0.38.

Typical Code: CIC100 (100 = fan diameter in cm)

Pressure Drop (Pa) = 0.6 x k x Velocity (m/s).

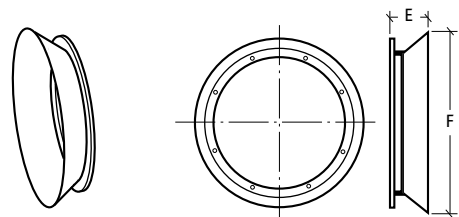

Backdraught Damper (Single)

Gravity operated backdraught damper, manufactured from heavy gauge galvanised steel with a pair of bolted flanges.

Standard Accessory Losses (k) (Air stream operated) 0.4

Typical Code: CBD100 (100 = fan diameter in cm) - 132°C

(For horizontal mounting only).

Pressure Drop (Pa) = 0.6 x k x Velocity (m/s).

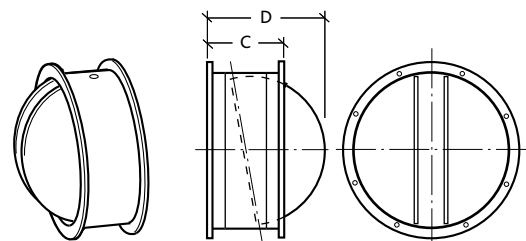

AV Mounts Spring Type

Supplied as a set of 4.

Typical Code: NAV49

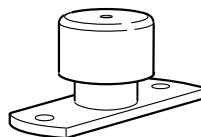

In-line Circular Attenuators

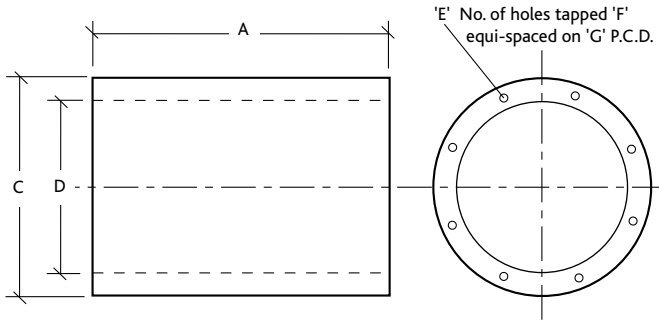

Attenuators shall be rigidly constructed from galvanised steel, internally lined with sound absorbing material not less than 100mm thick retained by galvanised steel perforated sheet.

Attenuator 'end faces' shall be drilled and tapped to match the flange details of the associated fan. Attenuator 'sound absorbing material' shall be chemically inert, non combustible, non-hygroscopic and vermin resistant.

Attenuator shall be tested in accordance with BS4718 :1971 ASTME 477.

All attenuators shall be suitable for internal and external use at any installed angle.

Standard - Typical code: CA100S.

Long - Typical code: CA100L

For podded silencer information please refer to Axial section.

Standard Un-podded

PERFORMANCE, DIMENSIONS (mm) & WEIGHTS

Dia.	Unit Code	Type	Dynamic Attenuation								Dimensions & Weights						Weight Kg
			Octave band mid frequency (Hz)								A	C	D	E	F	G	
			125	250	500	1K	2K	4K	8K								
315mm	CA31S	Standard Un-podded	-1	-2	-4	-7	-9	-7	-5	315	515	315	8	M8	355	8.0	
350mm	CA35S	Standard Un-podded	-1	-2	-4	-7	-9	-7	-5	355	555	355	8	M8	395	11.0	
400mm	CA40S	Standard Un-podded	-2	-3	-5	-7	-9	-6	-5	400	600	400	8	M10	450	16.0	
450mm	CA45S	Standard Un-podded	-2	-3	-6	-7	-8	-6	-5	450	650	450	8	M10	500	20.0	
500mm	CA50S	Standard Un-podded	-2	-3	-6	-8	-8	-6	-4	500	700	500	12	M10	560	23.0	
560mm	CA56S	Standard Un-podded	-2	-4	-7	-8	-8	-5	-4	560	760	560	12	M10	620	25.0	
630mm	CA63S	Standard Un-podded	-2	-4	-8	-9	-8	-5	-4	630	830	630	12	M10	690	30.0	
710mm	CA71S	Standard Un-podded	-3	-5	-8	-9	-7	-5	-4	710	910	710	16	M10	770	34.0	
800mm	CA80S	Standard Un-podded	-3	-5	-9	-8	-7	-4	-3	800	1000	800	16	M10	860	73.0	
900mm	CA90S	Standard Un-podded	-3	-6	-9	-8	-6	-4	-2	900	1100	900	16	M12	970	92.0	
1000mm	CA100S	Standard Un-podded	-3	-6	-9	-8	-6	-4	-2	1000	1200	1000	16	M12	1070	111.0	
1120mm	CA112S	Standard Un-podded	-4	-6	-9	-7	-6	-3	-2	1120	1320	1120	20	M12	1190	143.0	
1250mm	CA125S	Standard Un-podded	-4	-7	-9	-7	-5	-3	-2	1250	1450	1250	20	M12	1320	188.0	

Note: Pressure drop negligible.

Long Un-podded

PERFORMANCE, DIMENSIONS (mm) & WEIGHTS

Dia.	Unit Code	Type	Dynamic Attenuation								Dimensions & Weights						Weight Kg
			Octave band mid frequency (Hz)								A	C	D	E	F	G	
			125	250	500	1K	2K	4K	8K								
315mm	CA31L	Long - Un-podded	-2	-3	-6	-12	-15	-13	-9	630	515	315	8	M8	355	15.0	
350mm	CA35L	Long - Un-podded	-2	-3	-6	-12	-15	-12	-8	710	555	355	8	M8	395	21.0	
400mm	CA40L	Long - Un-podded	-3	-3	-7	-13	-14	-12	-8	800	600	400	8	M10	450	30.0	
450mm	CA45L	Long - Un-podded	-3	-4	-8	-13	-14	-11	-7	900	650	450	8	M10	500	38.0	
500mm	CA50L	Long - Un-podded	-3	-4	-10	-14	-13	-10	-7	1000	700	500	12	M10	560	42.0	
560mm	CA56L	Long - Un-podded	-3	-5	-12	-14	-13	-10	-7	1120	760	560	12	M10	620	47.0	
630mm	CA63L	Long - Un-podded	-3	-6	-13	-15	-13	-9	-6	1260	830	630	12	M10	690	56.0	
710mm	CA71L	Long - Un-podded	-4	-6	-13	-15	-12	-9	-6	1420	910	710	16	M10	770	63.0	
800mm	CA80L	Long - Un-podded	-4	-8	-14	-14	-11	-8	-5	1600	1000	800	16	M10	860	133.0	
900mm	CA90L	Long - Un-podded	-5	-10	-15	-14	-10	-6	-3	1800	1100	900	16	M12	970	166.0	
1000mm	CA100L	Long - Un-podded	-6	-11	-15	-14	-10	-6	-3	2000	1200	1000	16	M12	1070	203.0	
1120mm	CA112L	Long - Un-podded	-6	-11	-15	-13	-10	-6	-3	2240	1320	1120	20	M12	1190	261.0	
1250mm	CA125L	Long - Un-podded	-6	-12	-15	-12	-9	-5	-3	2500	1450	1250	20	M12	1320	343.0	

Note: Pressure drop negligible.

ANCILLARIES FOR AXIAL FANS - DETAILS CONT.

Vertical Discharge Cowl

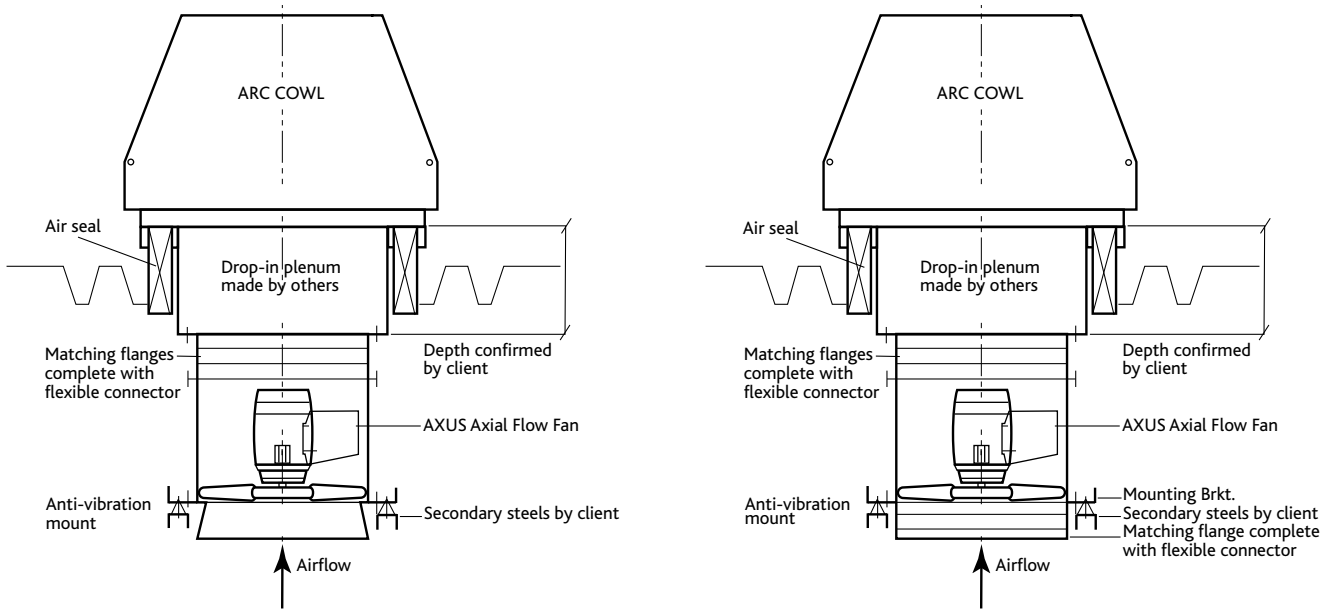

VERTICAL DISCHARGE COWL - DIMENSIONS

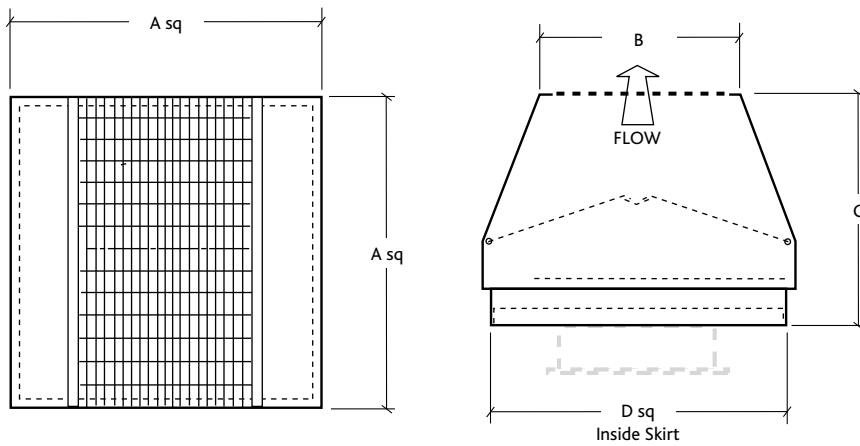

DIMENSIONS (mm) & WEIGHTS

Code	A	B	C	D	Max Weight Kg
ARC56	845	570	535	786	22
ARC71	1100	770	760	1045	37
ARC100	1295	1000	880	1234	79
ARC125	1795	1300	1160	1738	213

For further assistance, please contact Nuair Technical on (029) 2085 8200.
Fans and Cowls are supplied separately.

CURB DIMENSIONS

CURB DIMENSIONS (mm) (300°C/400°C UNITS)

Code	A	B	C	D
ARC56	600	75	675	746
ARC71	800	100	875	1016
ARC100	1000	100	1100	1198
ARC125	1500	100	1600	1700

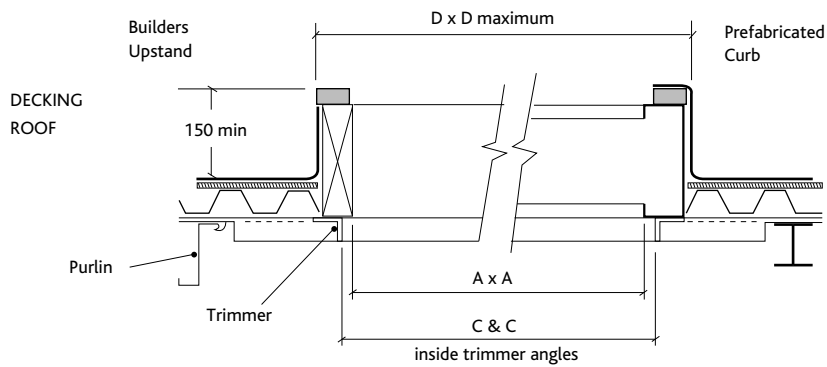
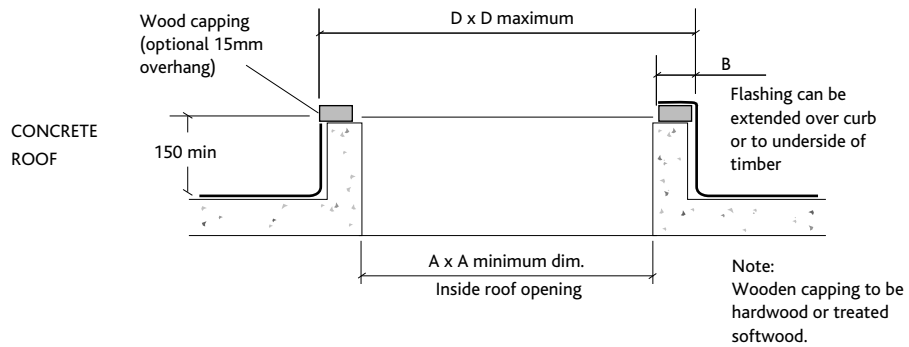

WIRING - AXUS AXIAL FANS

2 Speed 3 phase Dual Wound Motors (D.O.L. starting both speeds)

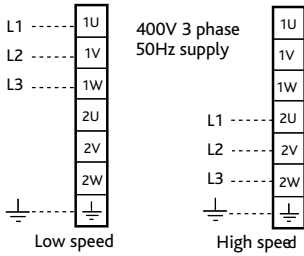

NOTE:
If a two speed starter is used it must have TWO contactors.
Individual wiring diagrams are included with each unit.

2 Speed 3 phase TAP/PAM Wound Motors (D.O.L. starting both speeds)

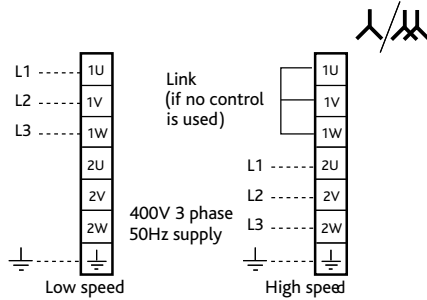

NOTE: If a two speed starter is used it must have THREE contactors.
Individual wiring diagrams are included with each unit.

Single Speed 3 Phase (Below 4kW)

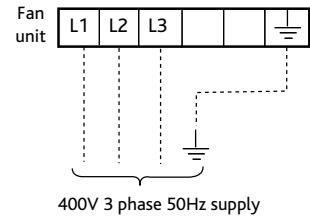

3 phase for Star/Delta Starting (4kW and above)

Note:
For D.O.L. (Direct On Line) operation or Inverter type Speed Control wire in DELTA

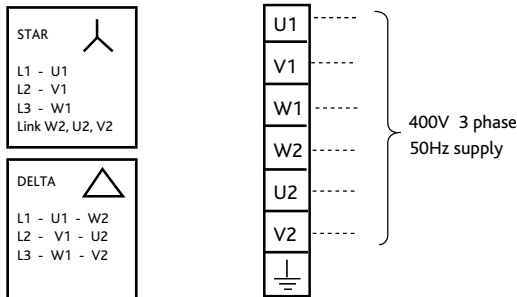

Note: individual wiring instructions are included with all units.

3 Phase input Matched Nuair Inverter Speed Control

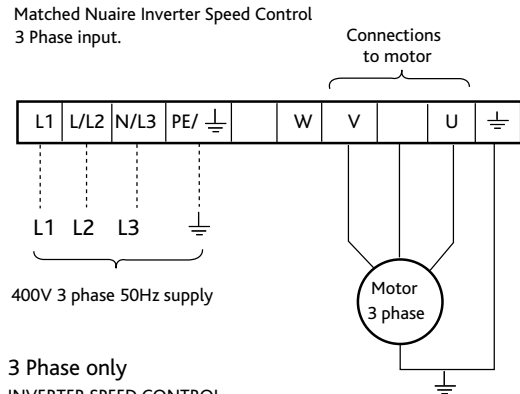

3 Phase only
INVERTER SPEED CONTROL

Notes:
Motors should be fitted with PTC Termistors. Refer to Inverter installation sheet for instructions on connection and programming.
Total length of motor leads should not exceed 50 metres.
If a screened motor cable is used, maximum length should be 25 metres. Consult out Technical Department if you wish to use longer leads. Inverters are configured to suit specific fans and control applications as described on the Customer Order free of charge.

Important: when the unit is operated in emergency mode, smoke extract operation, all controls must be bypassed.

CONSULTANTS SPECIFICATION

FAN SPECIFICATION - SMOKE EXTRACT

The ventilation fan Unit shall be configured and arranged as detailed on the drawings and in accordance with the schedule of equipment and shall be of the High Temperature AXUS axial flow fan as manufactured by Nuaire. The units shall be manufactured heavy gauge galvanised corrosion resistant steel to BS EN10142 1991. The case shall be fitted with an external terminal box to IP55. The fan impeller and motor shall be direct drive with IE2 high efficiency motors to BS5000 as standard and shall be foot mounted TENV type with IP55 enclosures and class H insulation in accordance with BS4999 part 20. The bearing type shall either:

- a) Sealed for life (below 160 frame).
- b) Regreasable (160 frame and above).

Motors shall be pre-wired to an external electrical terminal box through weatherproof flexible conduit to IP55.

The units shall be suitable for operation in ambient temperatures up to 60°C and a one off operation of 300°C for 2 hours to class F300/120 minutes or 400°C for 2 hours to class F400/120 minutes.

The unit shall be certified to EN12101-3. The unit has been independently tested for high temperature operation by BSRIA and certified by BSI. The unit is suitable for operating in smoke reservoir and non smoke reservoir applications. A two speed version of the unit to be provided where specified and controlled in accordance with the specification and manufacturers recommendations.

The unit shall be supplied with all necessary ancillaries as recommended by the manufacturer and in accordance with the equipment schedule.

The contractor shall allow for all necessary ductwork transformations to and from the fan unit and any associated components in accordance with the manufacturers recommendations, DW 144 and general good practice.

The impeller blades shall be of special aero-foil section giving excellent performance and low noise characteristic manufactured from cast aluminium alloy (300°C). All units shall be suitable for internal and external operation and can be installed any angle.

The units will be provided complete with matching flanges, flexible connections, anti vibration mounts and all other necessary components to complete the installation and shall be in accordance with the manufacturer's specification.

The unit and ancillaries shall be supplied with a 3 year warranty.

The unit shall be of the High Temperature AXUS type as manufactured by Nuaire Ltd.